



Propel™

Design guide for applications and greenfield designs

COMMSCOPE®

Contents

Introduction	3	MP012 OM4/OM5 multimode UPC assemblies	38
IEEE optical application up to 400G	4	MP012 singlemode APC assemblies	44
IEEE optical applications for 800G/MSA	5	MP012 basic channels	49
MPO (multiple fiber push-on) connectors	6	MP024 basic channels	54
MP016 OM4/OM5 multimode APC assemblies	8	Singlemode CS-LC Uniboot	58
MP016 singlemode APC assemblies	13	Panel annex	60
MP016 basic channels	18		
MP08 OM4/OM5 multimode UPC assemblies	25		
MP08 singlemode APC assemblies	27		
MP08 OM4/OM5 multimode APC assemblies	28		
MP08 basic channels	31		

Power forward with the speed and agility of Propel

Data center managers are under intensifying pressure to do more with less. Data transfer speeds are accelerating—100G to 200G to 400G and beyond. Architectures are flattening and fiber densities increasing. Ultra-low-loss cabling and connectivity is fast becoming the rule, not the exception. And all of this is occurring as budgets, migration schedules and manpower continue to shrink.

In short, the rules of the game are changing in real time. CommScope keeps you two steps ahead with Propel.

Designed for what's next, Propel is a modular, ultra-low loss, high-speed fiber platform that enables you to easily scale and adapt your infrastructure as needed, wherever it is needed. High-density fiber panels and interchangeable modules and adapters maximize design options while reducing deployment time, cost and complexity. 16-fiber connectivity provides easier migration to more efficient 400G/800G deployments while fully supporting legacy 8-, 4- and 2-fiber applications. QR-coded components for optical performance verification make it easier to manage.

Backed by the global reach of an industry leader, the Propel fiber platform delivers the performance, support and product availability you need to thrive in a frenetic, fast-paced environment. It's everything you expect from CommScope—and then some.

About this guide

This design guide provides an at-a-glance reference of Propel's components, configurations and data center applications. It is designed to help you customize an infrastructure platform to address your immediate needs and take you through multiple generations of upgrades. For more information on the Propel portfolio and its capabilities, please contact your CommScope representative or visit www.commscope.com/propel.



IEEE optical application up to 400G

VR (MM)	Short Reach	50 m
SR (MM)	Short Reach	100 - 150 m
DR (SM)	Data Center Reach	500 m
FR (SM)	Fiber Reach	2 km
LR (SM)	Long Reach	2 - 10 km
ER (SM)	Extended Reach	10 - 40 km
1 km = 1000 m		

Rate	Multimode		Reach	Duplex	Multi-	Lane Rate	IEEE Project
	PMD	Media		Parallel	wavelengths		
25G	SR	1-Pair MM	100 m	2	1	25G	802.3by (2016)
	SR4	4-Pair MM	150m	8	1	10G	802.3ba (2016)
40G	FR	1-Pair SM	2 km	2	1	40G	802.3bg (2011)
	LR4	1-Pair SM	10 km	2	4	10G	802.3ba (2016)
	ER4	1-Pair SM	40 km	2	4	10G	802.3bm (2015)
50G	SR	1-Pair MM	100 m	2	1	50G	802.3cd (2018)
	FR	1-Pair SM	2 km	2	1	50G	802.3cd (2018)
	LR	1-Pair SM	10 km	2	1	50G	802.3cd (2018)
100G	SR2	2-Pair MM	100 m	4	1	50G	802.3cd (2018)
	SR4	4-Pair MM	100 m	8	1	25G	802.3bm (2015)
	SR10	10-Pair MM	150 m	20	1	10G	802.3ba (2016)
	DR	1-Pair SM	500 m	2	1	100G	802.3cd (2018)
	LR4	1-Pair SM	2 km	2	1	25G	802.3ba (2016)
200G	ER4	1-Pair SM	10 km	2	4	25G	MSA
	SR1.4	1-Pair MM	100 m	2	4	50G	802.3cd (2018)
	SR4	4-Pair MM	100 m	8	1	50G	802.3bs (2017)
	DR4	4-Pair SM	500 m	8	1	50G	802.3bs (2017)
	FR4	1-Pair SM	2 km	2	4	50G	802.3bs (2017)
400G	LR4	1-Pair SM	10 km	2	4	50G	802.3bs (2017)
	SR4.2	4-Pair MM	OM4-100 m/ OM5-150 m	8	2	50G	802.3cm (2019)
	SR8	8-Pair MM	100 m	16	1	50G	802.3cm (2019)
	SR16	16-Pair MM	100 m	32	1	25G	802.3bs (2017)
	DR4	4-Pair SM	500 m	8	1	100G	802.3bs (2017)
400G	FR8	1-Pair SM	2 km	2	8	50G	802.3bs (2017)
	LR8	1-Pair SM	10 km	2	8	50G	802.3bs (2017)

IEEE optical applications for 800G/MSA

Rate	Multimode		Reach	Duplex	Wavelengths	Lane Rate	800G MSA
	PMD	Media		Parallel			
800G	800G-VR8	MM	50 m	16	1	100G	IEEE 802.3df
	800G-SR8	MM	100 m	16	1	100G	IEEE 802.3df
	800G-DR8	SM	500 m	16	1	100G	IEEE 802.3df
	800G-FR	SM	2 km	16/8/2	4	100G	IEEE 802.3df
	LR-4-6	SM	6 km	2	4	100G	IEEE 802.3df
	LR	SM	10 km	16/4	4	200G	IEEE 802.3df
	LR (High Loss)	SM	10 km	2	4	200G	IEEE 802.3df
	ER	SM	40 km	2	1	200G	IEEE 802.3df
	ZR	SM	80-120 km	2	1	200G	OIF

Options for 800G include 100G short reach multimode applications for in-row VR connections or likely breakouts as well as a 100m longer reach with the possibility a longer reach option TBD.

The transceiver options have narrowed since the applications are using 16 fibers MM or SM, or multiplexed duplex for longer reach SM applications.

MPO (multiple fiber push-on) connectors



Transceivers accept key up connectors whether MPO or duplex.

All solutions shown are ULL Method B Enhanced Polarity. Cable assemblies connect via Method B aligned keys including:

- Singlemode, OM4 and OM5 multimode
- Inline adapters and modules front & rear

Panel Capacity - Adapter packs/Module by size					
LC Duplex = MPO Ports	8-fiber	12-fiber	16-fiber	24-fiber	
Ports	6/blade	4/blade	3/blade	2/blade	
1RU	72	18	12	9	6
2RU	144	36	24	18	12
4RU	288	72	48	36	24

MPO16 Solutions

MPO16 OM4/OM5 multimode APC assemblies

MPO16 multimode APC trunk cables

1 U	2 G	3 X	4 R	5 Z	6 R	7 Z	8 8	9 R	10 -	11 M	12 J	13 F	14-16 010
Construction type U Ultra-low loss	Cable family 3 Trunk, LSZH CPR B2ca G Trunk, Plenum J Trunk, Dual Rated (OFNR/LSZH)	Fiber type X OM4 multimode V OM5 WB multimode	Connector 1 RZ 16f MPO MM APC (Pinned)	Connector 2 RZ 16f MPO MM APC (Pinned)	Cordage size 8 16f PmP Trunk, 3.0mm SU	Fiber count R 16-fiber S 32-fiber H 48-fiber U 64-fiber L 96-fiber Q 128-fiber M 144-fiber N 192-fiber	Color M OM4 Aqua N OM5 Lime green	Breakout length J 22" Break Propel No Pull Grip K 22" Break Propel Pull Grip	UOM F Feet M Meter	Length 010-999 ft 003-305 m			

MPO16 multimode APC patch cords

1 U	2 Q	3 X	4 R	5 V	6 R	7 V	8 7	9 R	10 -	11 M	12 A	13 F	14-16 003
Construction type U Ultra-low loss	Cable family Q Plenum Array R Dual Rated (OFNR/LSZH)	Fiber type X OM4 multimode V OM5 WB multimode	Connector 1 RV 16f MPO MM APC (Non-Pinned)	Connector 2 RV 16f MPO MM APC (Non-Pinned)	Cordage size 7 16f PmP Array Cord, 3mm	Fiber count R 16-fiber	Color M OM4 Aqua N OM5 Lime green	Breakout length A No gland	UOM F Feet M Meter	Length 003-999 ft 001-305 m			

400GBASE-SR8 to 400GBASE-SR8 (100m)
800GBASE-SR8 to 800GBASE-SR8 (100m)
800GBASE-VR8 to 800GBASE-VR8 (50m)

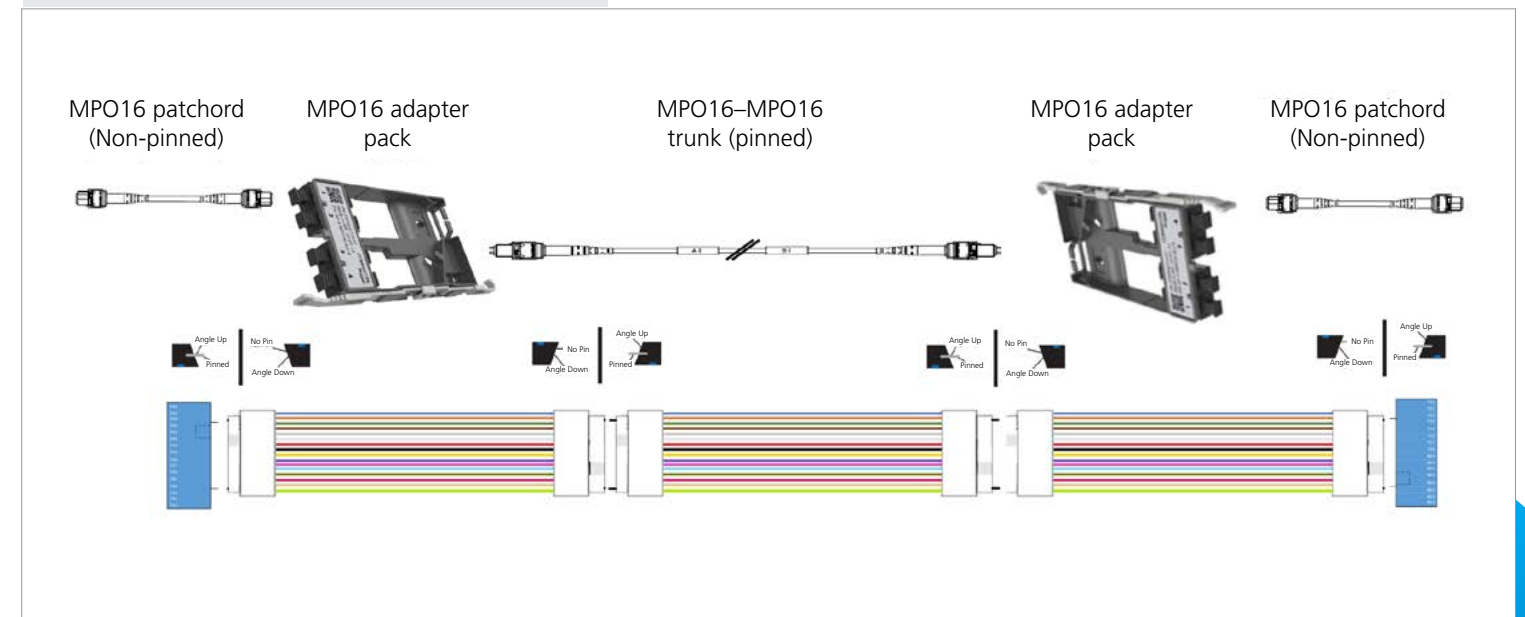

	Material ID	Product Number	Description	Fiber Type	Fiber Count	Front Interface	Rear Interface
16-fiber adapter packs							
9 per 1RU	760252804	PPL-AP-8-MPO16-ALL-B	Propel pass-through adapter pack, Type B	All	128	8 MPO16 Key Up with dust caps	8 MPO16 Key Up with dust caps
18 per 1 RU	760252806	PPL-AP-4-MPO16-ALL-B	Propel pass-through adapter pack, Type B	All	64	4 MPO16 Key Up with dust caps	4 MPO16 Key Up with dust caps
12 per 1 RU	760252805	PPL-AP-6-MPO16-ALL-B	Propel pass-through adapter pack, Type B	All	96	6 MPO16 Key Up with dust caps	6 MPO16 Key Up with dust caps
6 per 1RU	760252803	PPL-AP-12-MPO16-ALL-B	Propel pass-through adapter pack, Type B	All	192	12 MPO16 Key Up with dust caps	12 MPO16 Key Up with dust caps

For panel ordering information, refer to panel annex in the back of this guide.

Note: MPO16 patchcord (non-pinned) can be used for direct connect between network electronics locally

MPO16 OM4/OM5 multimode APC assemblies

MPO16 multimode APC trunk cables

1 U	2 G	3 X	4 R	5 Z	6 R	7 Z	8 8	9 R	10 -	11 M	12 J	13 F	14-16 010
Construction type U Ultra-low loss	Cable family 3 Trunk, LSZH CPR B2ca G Trunk, Plenum J Trunk, Dual Rated (OFNR/LSZH)	Fiber type X OM4 multimode V OM5 WB multimode	Connector 1 RZ 16f MPO MM APC (Pinned)	Connector 2 RZ 16f MPO MM APC (Pinned)	Cordage size 8 16f PmP Trunk, 3.0mm SU	Fiber count R 16-fiber S 32-fiber H 48-fiber U 64-fiber L 96-fiber Q 128-fiber M 144-fiber N 192-fiber	Color M OM4 Aqua N OM5 Lime green	Breakout length J 22" Break Propel No Pull Grip K 22" Break Propel Pull Grip	UOM F Feet M Meter	Length 010-999 ft 003-305 m			

MPO16 multimode APC patch cords

1 U	2 Q	3 X	4 R	5 V	6 R	7 V	8 7	9 R	10 -	11 M	12 A	13 F	14-16 003
Construction type U Ultra-low loss	Cable family Q Plenum Array R Dual Rated (OFNR/LSZH)	Fiber type X OM4 multimode V OM5 WB multimode	Connector 1 RV 16f MPO MM APC (Non-Pinned)	Connector 2 RV 16f MPO MM APC (Non-Pinned)	Cordage size 7 16f PmP Array Cord, 3mm	Fiber count R 16-fiber	Color M OM4 Aqua N OM5 Lime green	Breakout length A No gland	UOM F Feet M Meter	Length 003-999 ft 001-305 m			

MPO16 multimode APC conversion array cords

1 U	2 Q	3 X	4 R	5 V	6 Q	7 V	8 7	9 R	10 -	11 M	12 D	13 F	14-16 003
Construction type U Ultra-low loss	Cable family Q Plenum Array R Dual Rated (OFNR/LSZH)	Fiber type X OM4 multimode V OM5 WB multimode	Connector 1 RV 16f MPO MM APC (Non-Pinned)	Connector 2 QV 8f MPO MM APC (Non-Pinned) QP 8f MPO MM UPC (Non-Pinned)	Cordage size 7 16f PmP Array Cord, 3mm	Fiber count R 16-fiber	Color M OM4 Aqua N OM5 Lime green	Breakout length D 12" E 24" H 48" L 72"	UOM F Feet M Meter	Length 12 in 3-999 ft 24 in 4-999 ft 48 in 6-999 ft 72 in 8-999 ft 12 in 1-305 m 24-48 in 2-305 m 72 in 3-305 m			

	Material ID	Product Number	Description	Fiber Type	Fiber Count	Front Interface	Rear Interface
16-fiber adapter packs							
9 per 1RU	760252804	PPL-AP-8-MPO16-ALL-B	Propel pass-through adapter pack, Type B	All	128	8 MPO16 Key Up with dust caps	8 MPO16 Key Up with dust caps
18 per 1 RU	760252806	PPL-AP-4-MPO16-ALL-B	Propel pass-through adapter pack, Type B	All	64	4 MPO16 Key Up with dust caps	4 MPO16 Key Up with dust caps
12 per 1 RU	760252805	PPL-AP-6-MPO16-ALL-B	Propel pass-through adapter pack, Type B	All	96	6 MPO16 Key Up with dust caps	6 MPO16 Key Up with dust caps
6 per 1RU	760252803	PPL-AP-12-MPO16-ALL-B	Propel pass-through adapter pack, Type B	All	192	12 MPO16 Key Up with dust caps	12 MPO16 Key Up with dust caps

400GBASE-SR8 to 2x200GBASE-SR4APC (100m)
 800GBASE-SR8 to 2x400GBASE-SR4APC (100m)
 800GBASE-VR8 to 2x400GBASE-VR8

Note: For 200GBASE-SR4 conversion array confirm with transceiver whether end requires APC or UPC

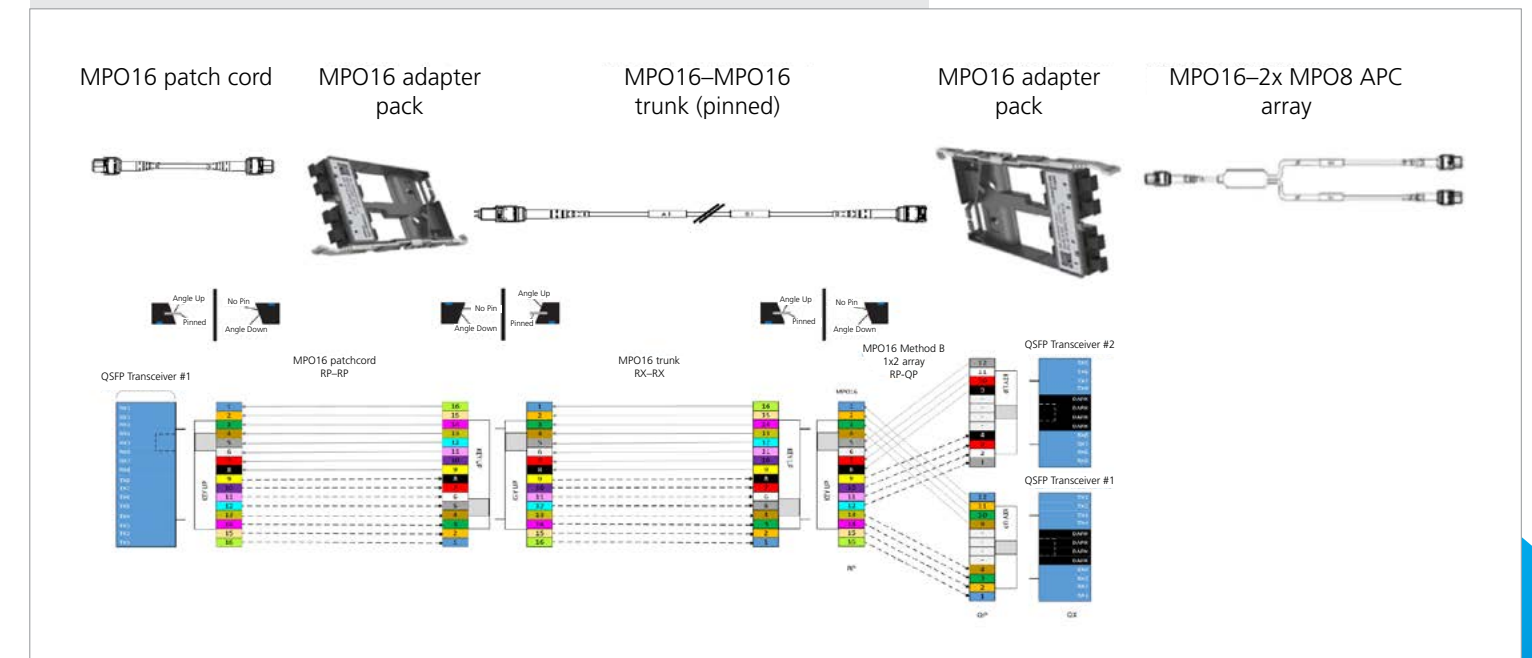

For panel ordering information, refer to panel annex in the back of this guide.

Note: MPO16 to 2xMPO8 Array cord (non-pinned) can be used for direct connect between network electronics locally

MPO16 OM4/OM5 multimode APC assemblies

MPO16 multimode APC trunk cables

1 U	2 G	3 X	4 R	5 Z	6 R	7 Z	8 8	9 R	10 -	11 M	12 J	13 F	14-16 010
Construction type U Ultra-low loss	Cable family 3 Trunk, LSZH CPR B2ca G Trunk, Plenum J Trunk, Dual Rated (OFNR/LSZH)	Fiber type X OM4 multimode V OM5 WB multimode	Connector 1 RZ 16f MPO MM APC (Pinned)	Connector 2 RZ 16f MPO MM APC (Pinned)	Cordage size 8 16f PmP Trunk, 3.0mm SU	Fiber count R 16-fiber S 32-fiber H 48-fiber U 64-fiber L 96-fiber Q 128-fiber M 144-fiber N 192-fiber	Color M OM4 Aqua N OM5 Lime green	Breakout length J 22" Break Propel No Pull Grip K 22" Break Propel Pull Grip	UOM F Feet M Meter	Length 010-999 ft 003-305 m			

MPO16 multimode APC patch cords

1 U	2 Q	3 X	4 R	5 V	6 R	7 V	8 7	9 R	10 -	11 M	12 A	13 F	14-16 003
Construction type U Ultra-low loss	Cable family Q Plenum Array R Dual Rated (OFNR/LSZH)	Fiber type X OM4 multimode V OM5 WB multimode	Connector 1 RV 16f MPO MM APC (Non-Pinned)	Connector 2 RV 16f MPO MM APC (Non-Pinned)	Cordage size 7 16f PmP Array Cord, 3mm	Fiber count R 16-fiber	Color M OM4 Aqua N OM5 Lime green	Breakout length A No gland	UOM F Feet M Meter	Length 003-999 ft 001-305 m			

SYSTEMAX Uniboot patch cords

1 U	2 D	3 X	4 L	5 U	6 6	7 2	8 -	9 M	10 X	11-12 010
Construction type U Ultra-low loss	Cable family D Plenum F LSZH/Riser	Fiber type X OM4 multimode V OM5 WB multimode	Connector 1 LU LC Uniboot	Connector 2 LU LC Uniboot	Cordage size K 1.5 mm 6 2.0 mm	Fiber count 2 2-fiber	Color M OM4 Aqua N OM5 Lime green	Breakout length X No breakout	UOM F Feet M Meter	Length 2-200 Feet 1-061 Meters

• Other lengths available please contact CommScope

	Material ID	Product Number	Description	Fiber Type	Fiber Count	Front Interface	Rear Interface
MPO16 modules							
9 per 1RU	760252353	PPL-DM-16AU-16LC-OM4-BEU	Propel ULL Distribution Module, Method B Enhanced	OM4	16	8 duplex LCs with internal shutters	1 MPO16/APC non-pinned with dust cap
	760252354	PPL-DM-16AU-16LC-OM5-BEU	Propel ULL Distribution Module, Method B Enhanced	OM5	16	8 duplex LCs with internal shutters	1 MPO16/APC non-pinned with dust cap
16-fiber adapter packs							
9 per 1RU	760252804	PPL-AP-8-MPO16-ALL-B	Propel pass-through adapter pack, Type B	All	128	8 MPO16 Key Up with dust caps	8 MPO16 Key Up with dust caps
18 per 1 RU	760252806	PPL-AP-4-MPO16-ALL-B	Propel pass-through adapter pack, Type B	All	64	4 MPO16 Key Up with dust caps	4 MPO16 Key Up with dust caps
12 per 1 RU	760252805	PPL-AP-6-MPO16-ALL-B	Propel pass-through adapter pack, Type B	All	96	6 MPO16 Key Up with dust caps	6 MPO16 Key Up with dust caps
6 per 1RU	760252803	PPL-AP-12-MPO16-ALL-B	Propel pass-through adapter pack, Type B	All	192	12 MPO16 Key Up with dust caps	12 MPO16 Key Up with dust caps

400GBASE-SR8 to 8x50GBASE-SR (100m)
800GBASE-VR8 to 8x100GBASE-VR1 (50m)
800GBASE-SR8 to 8x100GBASE-SR1 (100m)

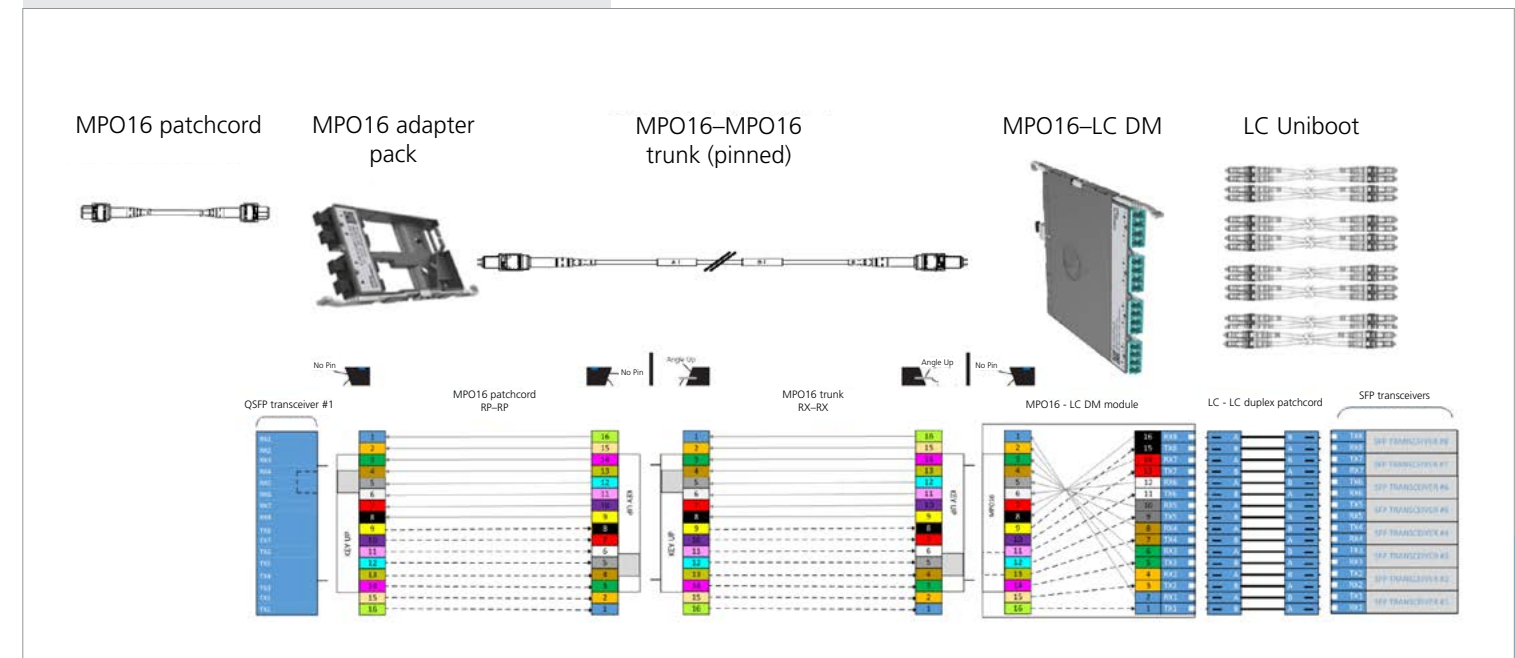

For panel ordering information, refer to panel annex in the back of this guide.

MPO16 OM4/OM5 multimode APC assemblies

MPO16 multimode APC trunk cables

1	2	3	4	5	6	7	8	9	10	11	12	13	14-16
U	G	X	R	Z	R	Z	8	R	-	M	J	F	010
Construction type U Ultra-low loss	Cable family 3 Trunk, LSZH CPR B2ca G Trunk, Plenum J Trunk, Dual Rated (OFNR/LSZH)	Fiber type X OM4 multimode V OM5 WB multimode	Connector 1 RZ 16f MPO MM APC (Pinned)	Connector 2 RZ 16f MPO MM APC (Pinned)	Cordage size 8 16f PmP Trunk, 3.0mm SU	Fiber count R 16-fiber S 32-fiber H 48-fiber U 64-fiber L 96-fiber Q 128-fiber M 144-fiber N 192-fiber	Color M OM4 Aqua N OM5 Lime green	Breakout length J 22" Break Propel No Pull Grip K 22" Break Propel Pull Grip	UOM F Feet M Meter	Length 010-999 ft 003-305 m			

MPO8 multimode APC array cords

1	2	3	4	5	6	7	8	9	10	11	12	13	14-16
U	Q	X	Q	V	L	U	F	8	-	M	D	F	003
Construction type U Ultra-low loss	Cable family Q Plenum Array R Dual Rated (OFNR/LSZH)	Fiber type X OM4 multimode V OM5 WB multimode	Connector 1 QV 8f MPO MM APC (Non-pinned) QP 8f MPO MM UPC (Non-Pinned)	Connector 2 LU LC Uniboot	Cordage size F 8f PmP Array Cord, 2 mm	Fiber count 8 8-fiber	Color M OM4 Aqua N OM5 Lime green	Breakout length D 12" E 24" H 48" L 72"	UOM F Feet M Meter	Length 12 in 3-999 ft 24 in 4-999 ft 48 in 6-999 ft 72 in 8-999 ft 12 in 1-305 m 24-48 in 2-305 m 72 in 3-305 m			

SYSTIMAX Uniboot patch cords

1	2	3	4	5	6	7	8	9	10	11-12
U	D	X	L	U	6	2	-	X	F	010
Construction type U Ultra-low loss	Cable family D Plenum F LSZH/Riser	Fiber type X OM4 multimode V OM5 WB multimode	Connector 1 LU LC Uniboot	Connector 2 LU LC Uniboot	Cordage size K 1.5 mm 6 2.0 mm	Fiber count 2 2-fiber	Color M OM4 Aqua N OM5 Lime green	Breakout length X No breakout	UOM F Feet M Meter	Length 2-200 Feet 1-061 Meters

• Other lengths available please contact CommScope

	Material ID	Product Number	Description	Fiber Type	Fiber Count	Front Interface	Rear Interface
MPO16 modules							
9 per 1RU	760252353	PPL-DM-16AU-16LC-OM4-BEU	Propel ULL Distribution Module, Method B Enhanced	OM4	16	8 duplex LCs with internal shutters	1 MPO16/APC non-pinned with dust cap
	760252354	PPL-DM-16AU-16LC-OM5-BEU	Propel ULL Distribution Module, Method B Enhanced	OM5	16	8 duplex LCs with internal shutters	1 MPO16/APC non-pinned with dust cap

200GBASE-SR4APC to 4x50GBASE-SR (100m)
400GBASE-SR4APC to 4x100GBASE-SR1 (100m)
400GBASE-VR4APC to 4x100GBASE-VR1

Note: For 200GBASE-SR4 array confirm with transceiver whether end requires APC or UPC

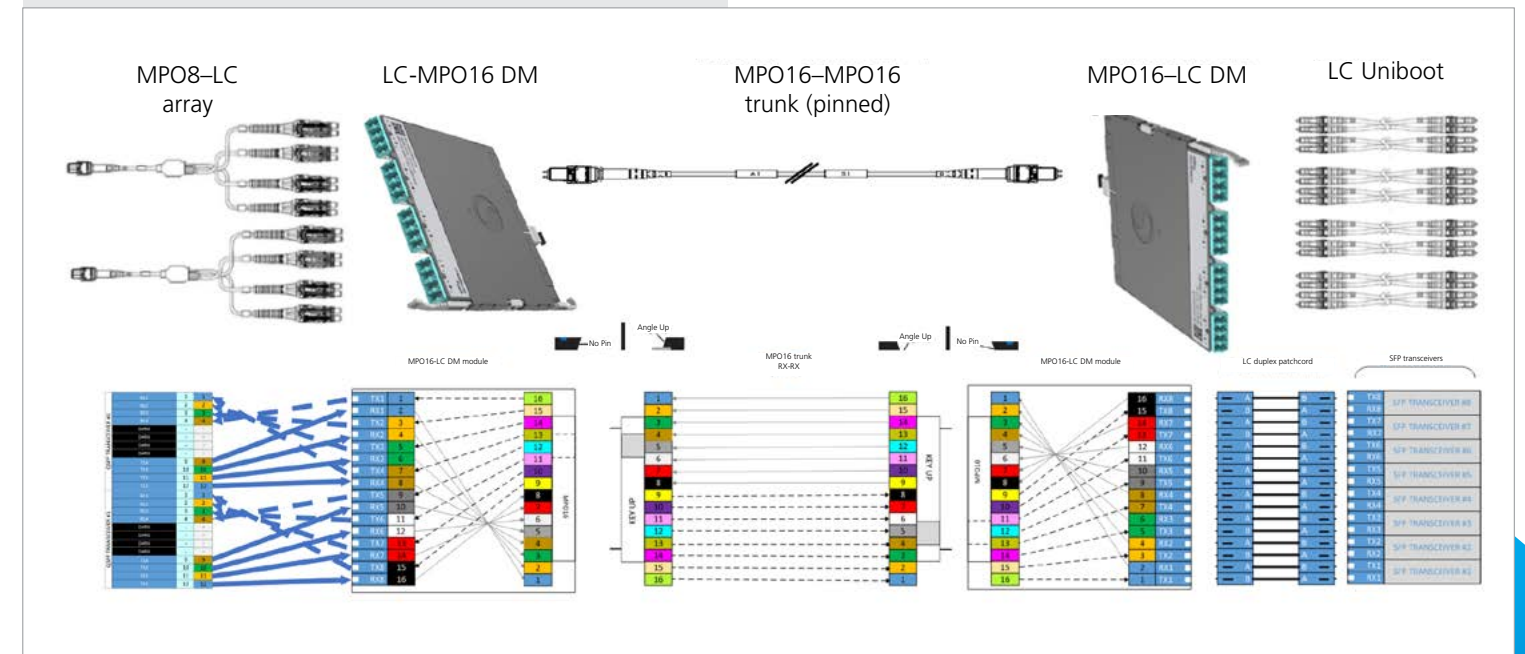

For panel ordering information, refer to panel annex in the back of this guide.

MPO16 OM4/OM5 multimode APC assemblies

MPO16 multimode APC trunk cables

1	2	3	4	5	6	7	8	9	10	11	12	13	14-16
U	G	X	R	Z	R	Z	8	R	-	M	J	F	010
Construction type U Ultra-low loss	Cable family 3 Trunk, LSZH CPR B2ca G Trunk, Plenum J Trunk, Dual Rated (OFNR/LSZH)	Fiber type X OM4 multimode V OM5 WB multimode	Connector 1 RZ 16f MPO MM APC (Pinned)	Connector 2 RZ 16f MPO MM APC (Pinned)	Cordage size 8 16f PmP Trunk, 3.0mm SU	Fiber count R 16-fiber S 32-fiber H 48-fiber U 64-fiber L 96-fiber Q 128-fiber M 144-fiber N 192-fiber	Color M OM4 Aqua N OM5 Lime green	Breakout length J 22" Break Propel No Pull Grip K 22" Break Propel Pull Grip	UOM F Feet M Meter	Length 010-999 ft 003-305 m			

MPO16 multimode APC conversion array cords

1	2	3	4	5	6	7	8	9	10	11	12	13	14-16
U	Q	X	R	V	Q	P	7	R	-	M	D	F	003
Construction type U Ultra-low loss	Cable family Q Plenum Array R Dual Rated (OFNR/LSZH)	Fiber type X OM4 multimode V OM5 WB multimode	Connector 1 RV 16f MPO MM APC (Non-Pinned)	Connector 2 QP 8f MPO MM UPC (Non-Pinned)	Cordage size 7 16f PmP Array Cord, 3mm	Fiber count R 16-fiber	Color M OM4 Aqua N OM5 Lime green	Breakout length D 12" E 24" H 48" L 72"	UOM F Feet M Meter	Length 12 in 3-999 ft 24 in 4-999 ft 48 in 6-999 ft 72 in 8-999 ft 12 in 1-305 m 24-48 in 2-305 m 72 in 3-305 m			

SYSTEMAX Uniboot patch cords

1	2	3	4	5	6	7	8	9	10	11-12
U	D	X	L	U	6	2	-	X	F	010
Construction type U Ultra-low loss	Cable family D Plenum F LSZH/Riser	Fiber type X OM4 multimode V OM5 WB multimode	Connector 1 LU LC Uniboot	Connector 2 LU LC Uniboot	Cordage size K 1.5 mm 6 2.0 mm	Fiber count 2 2-fiber	Color M OM4 Aqua N OM5 Lime green	Breakout length X No breakout	UOM F Feet M Meter	Length 2-200 Feet 1-061 Meters

• Other lengths available please contact CommScope

	Material ID	Product Number	Description	Fiber Type	Fiber Count	Front Interface	Rear Interface
MPO16 modules							
9 per 1RU	760252353	PPL-DM-16AU-16LC-OM4-BEU	Propel ULL Distribution Module, Method B Enhanced	OM4	16	8 duplex LCs with internal shutters	1 MPO16/APC non-pinned with dust cap
	760252354	PPL-DM-16AU-16LC-OM5-BEU	Propel ULL Distribution Module, Method B Enhanced	OM5	16	8 duplex LCs with internal shutters	1 MPO16/APC non-pinned with dust cap
16-fiber adapter packs							
9 per 1RU	760252804	PPL-AP-8-MPO16-ALL-B	Propel pass-through adapter pack, Type B	All	128	8 MPO16 Key Up with dust caps	8 MPO16 Key Up with dust caps
18 per 1RU	760252806	PPL-AP-4-MPO16-ALL-B	Propel pass-through adapter pack, Type B	All	64	4 MPO16 Key Up with dust caps	4 MPO16 Key Up with dust caps
12 per 1RU	760252805	PPL-AP-6-MPO16-ALL-B	Propel pass-through adapter pack, Type B	All	96	6 MPO16 Key Up with dust caps	6 MPO16 Key Up with dust caps
6 per 1RU	760252803	PPL-AP-12-MPO16-ALL-B	Propel pass-through adapter pack, Type B	All	192	12 MPO16 Key Up with dust caps	12 MPO16 Key Up with dust caps

40GBASE-SR4 to 4x10GBASE-SR (150m)
100GBASE-SR4 to 4x25GBASE-SR (100m)

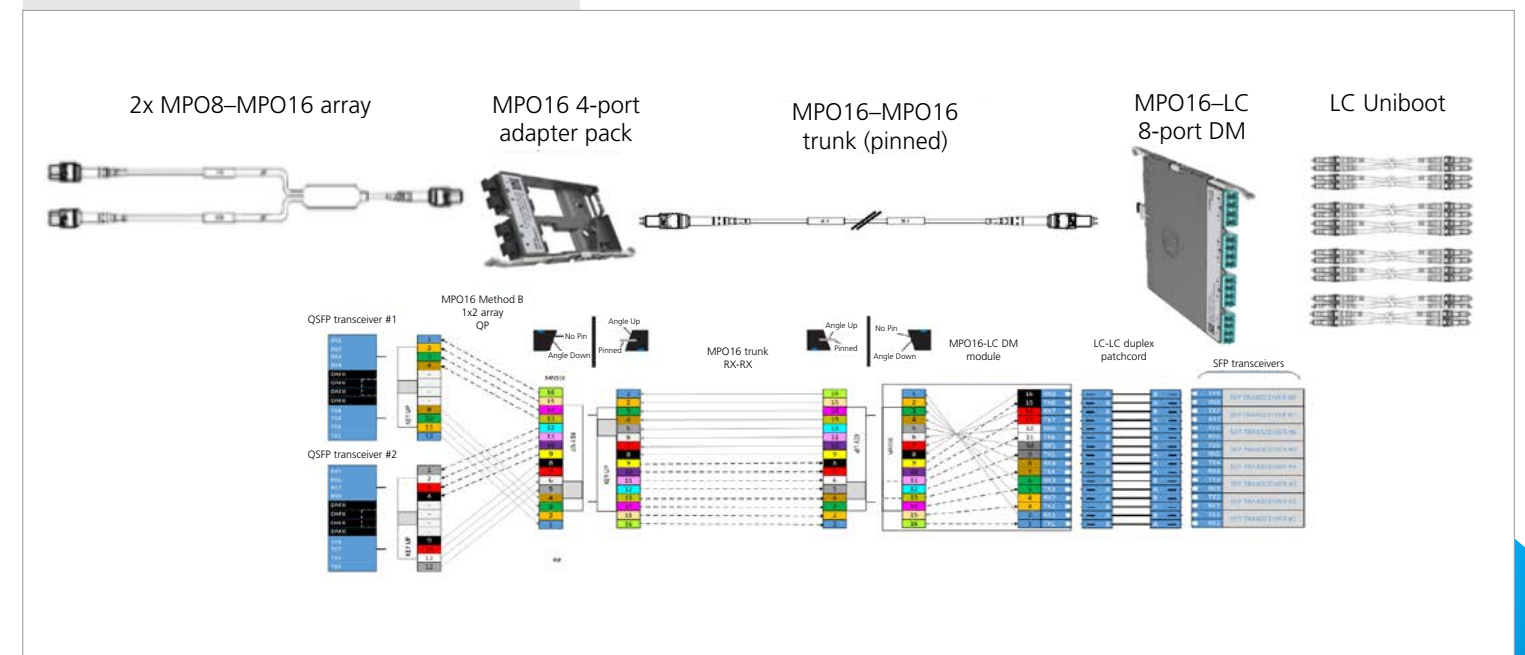

For panel ordering information, refer to panel annex in the back of this guide.

MPO16 singlemode APC assemblies

MPO16 singlemode APC trunk cables

1 U	2 G	3 G	4 R	5 X	6 R	7 X	8 8	9 R	10 -	11 J	12 J	13 F	14-16 010
Construction type U Ultra-low loss	Cable family 3 Trunk, LSZH CPR B2ca G Trunk, Plenum J Trunk, Dual Rated (OFNR/LSZH)	Fiber type G Singlemode (AZ)	Connector 1 RX 16f MPO SM APC (Pinned)	Connector 2 RX 16f MPO SM APC (Pinned)	Cordage size 8 16f PmP Trunk, 3.0mm SU	Fiber count R 16-fiber S 32-fiber H 48-fiber U 64-fiber L 96-fiber Q 128-fiber M 144-fiber N 192-fiber	Color J Yellow	Breakout length J 22" Break Propel No Pull Grip K 22" Break Propel Pull Grip	UOM F Feet M Meter	Length 010-999 ft 003-305 m			

MPO16 singlemode APC conversion array cords

1 U	2 Q	3 G	4 R	5 P	6 Q	7 P	8 7	9 R	10 -	11 J	12 D	13 F	14-16 003
Construction type U Ultra-low loss	Cable family Q Plenum Array R Dual Rated (OFNR/LSZH)	Fiber type G Singlemode (AZ)	Connector 1 RP 16f MPO SM APC (Non-Pinned)	Connector 2 QP 8f MPO SM APC (Non-Pinned)	Cordage size 7 16f PmP Array Cord, 3mm	Fiber count R 16-fiber	Color J Yellow	Breakout length D 12" E 24" H 48" L 72"	UOM F Feet M Meter	Length 12 in 3-999 ft 24 in 4-999 ft 48 in 6-999 ft 72 in 8-999 ft 12 in 1-305 m 24-48 in 2-305 m 72 in 3-305 m			

400GBASE-DR4 to 400GBASE-DR4 (500m)

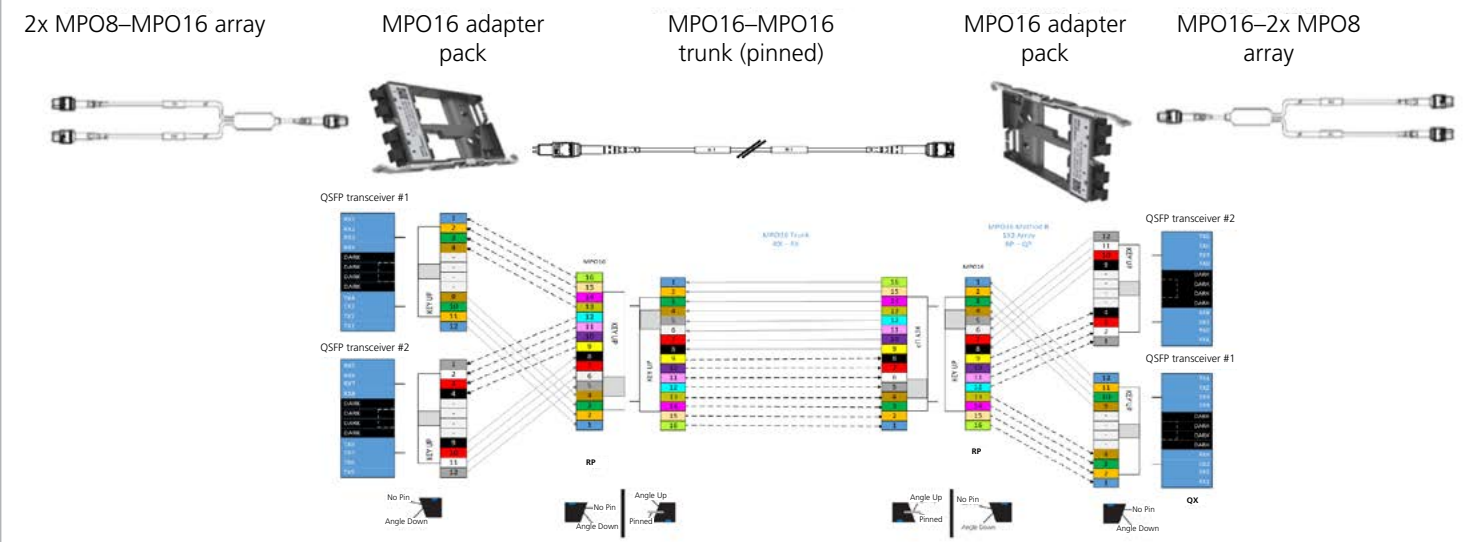

	Material ID	Product Number	Description	Fiber Type	Fiber Count	Front Interface	Rear Interface
16-fiber adapter packs							
9 per 1RU	760252804	PPL-AP-8-MPO16-ALL-B	Propel pass-through adapter pack, Type B	All	128	8 MPO16 Key Up with dust caps	8 MPO16 Key Up with dust caps
18 per 1RU	760252806	PPL-AP-4-MPO16-ALL-B	Propel pass-through adapter pack, Type B	All	64	4 MPO16 Key Up with dust caps	4 MPO16 Key Up with dust caps
12 per 1RU	760252805	PPL-AP-6-MPO16-ALL-B	Propel pass-through adapter pack, Type B	All	96	6 MPO16 Key Up with dust caps	6 MPO16 Key Up with dust caps
6 per 1RU	760252803	PPL-AP-12-MPO16-ALL-B	Propel pass-through adapter pack, Type B	All	192	12 MPO16 Key Up with dust caps	12 MPO16 Key Up with dust caps

For panel ordering information, refer to panel annex in the back of this guide.

MPO16 singlemode APC assemblies

MPO16 singlemode APC trunk cables

1	2	3	4	5	6	7	8	9	10	11	12	13	14-16
U	G	G	R	X	R	X	8	R	-	J	J	F	010
Construction type U Ultra-low loss	Cable family 3 Trunk, LSZH CPR B2ca G Trunk, Plenum J Trunk, Dual Rated (OFNR/LSZH)	Fiber type G Singlemode (AZ)	Connector 1 RX 16f MPO SM APC (Pinned)	Connector 2 RX 16f MPO SM APC (Pinned)	Cordage size 8 16f PmP Trunk, 3.0mm SU	Fiber count R 16-fiber S 32-fiber H 48-fiber U 64-fiber L 96-fiber Q 128-fiber M 144-fiber N 192-fiber	Color J Yellow	Breakout length J 22" Break Propel No Pull Grip K 22" Break Propel Pull Grip	UOM F Feet M Meter	Length 010-999 ft 003-305 m			

MPO16 singlemode APC conversion array cords

1	2	3	4	5	6	7	8	9	10	11	12	13	14-16
U	Q	G	R	P	Q	P	7	R	-	J	D	F	003
Construction type U Ultra-low loss	Cable family Q Plenum Array R Dual Rated (OFNR/LSZH)	Fiber type G Singlemode (AZ)	Connector 1 RP 16f MPO SM APC (Non-Pinned)	Connector 2 QP 8f MPO SM APC (Non-Pinned)	Cordage size 7 16f PmP Array Cord, 3mm	Fiber count R 16-fiber	Color J Yellow	Breakout length D 12" E 24" H 48" L 72"	UOM F Feet M Meter	Length 12 in 3-999 ft 24 in 4-999 ft 48 in 6-999 ft 72 in 8-999 ft 12 in 1-305 m 24-48 in 2-305 m 72 in 3-305 m			

SYSTEMAX Uniboot patch cords

1	2	3	4	5	6	7	8	9	10	11-12			
U	D	G	L	U	L	U	6	2	-	J	X	F	010
Construction type U Ultra-low loss	Cable family D Plenum F LSZH/Riser	Fiber type G Singlemode (AZ)	Connector 1 LU LC Uniboot	Connector 2 LU LC Uniboot	Cordage size K 1.5 mm 6 2.0 mm	Fiber count 2 2-fiber	Color J Yellow	Breakout length X No breakout	UOM F Feet M Meter	Length 2-200 Feet 1-061 Meters			

• Other lengths available please contact CommScope

SN singlemode jumpers

1	2	3	4	5	6	7	8	9	10	11	12	13	14-16
U	D	G	S	N	S	N	K	2	-	J	X	F	003
Construction type U Ultra-low loss	Cable family D Plenum F Dual Rated (OFNR/LSZH)	Fiber type G Singlemode	Connector 1 SN SN	Connector 2 SN SN LU LC Uniboot	Cordage size K 1.5 mm	Fiber count 2 2-fiber	Color J Yellow	Breakout length X No Breakout	UOM F Feet M Meter	Length 001-999 ft 001-999 m			

	Material ID	Product Number	Description	Fiber Type	Fiber Count	Front Interface	Rear Interface
MPO16 modules							
9 per 1RU	760252352	PPL-DM-16AU-16LC-SM-BEU	Propel ULL Distribution Module, Method B Enhanced	OS2	16	8 duplex LCs with internal shutters	1 MPO16/APC non-pinned with dust cap
16-fiber adapter packs							
9 per 1RU	760252804	PPL-AP-8-MPO16-ALL-B	Propel pass-through adapter pack, Type B	All	128	8 MPO16 Key Up with dust caps	8 MPO16 Key Up with dust caps
18 per 1RU	760252806	PPL-AP-4-MPO16-ALL-B	Propel pass-through adapter pack, Type B	All	64	4 MPO16 Key Up with dust caps	4 MPO16 Key Up with dust caps
12 per 1RU	760252805	PPL-AP-6-MPO16-ALL-B	Propel pass-through adapter pack, Type B	All	96	6 MPO16 Key Up with dust caps	6 MPO16 Key Up with dust caps
6 per 1RU	760252803	PPL-AP-12-MPO16-ALL-B	Propel pass-through adapter pack, Type B	All	192	12 MPO16 Key Up with dust caps	12 MPO16 Key Up with dust caps
SN modules							
18 per 1RU	760252355	PPL-DM-16AU-8SN-SM-BEU	Propel ULL Distribution Module, Method B Enhanced	OS2	16	8 SNs with dust caps	1 MPO16/APC non-pinned with dust cap

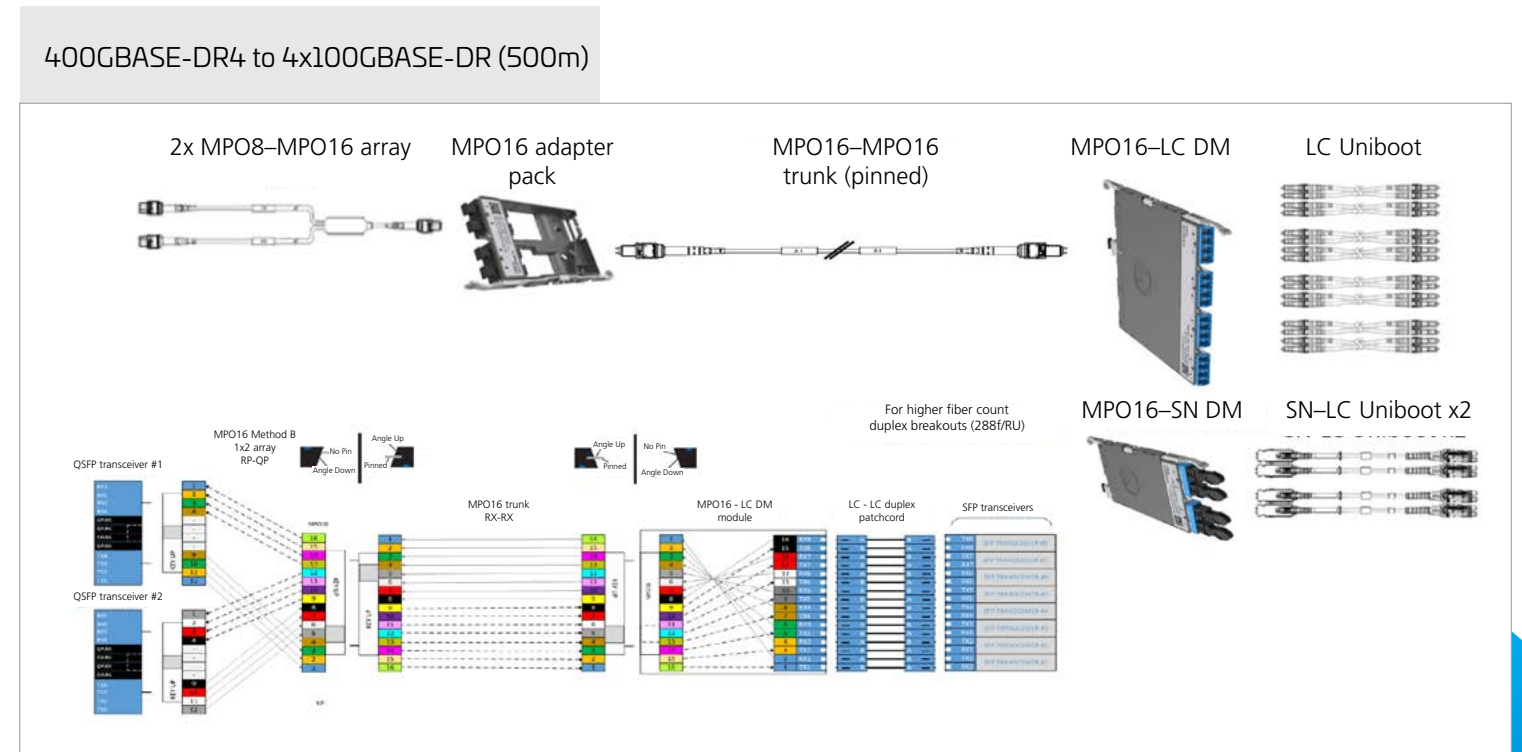

For panel ordering information, refer to panel annex in the back of this guide.

MPO16 singlemode APC assemblies

MPO16 singlemode APC trunk cables

1 U	2 G	3 G	4 R	5 X	6 R	7 X	8 8	9 R	10 -	11 J	12 J	13 F	14-16 010
Construction type U Ultra-low loss	Cable family 3 Trunk, LSZH CPR B2ca G Trunk, Plenum J Trunk, Dual Rated (OFNR/LSZH)	Fiber type G Singlemode (AZ)	Connector 1 RX 16f MPO SM APC (Pinned)	Connector 2 RX 16f MPO SM APC (Pinned)	Cordage size 8 16f PmP Trunk, 3.0mm SU	Fiber count R 16-fiber S 32-fiber H 48-fiber U 64-fiber L 96-fiber Q 128-fiber M 144-fiber N 192-fiber	Color J Yellow	Breakout length J 22" Break Propel No Pull Grip K 22" Break Propel Pull Grip	UOM F Feet M Meter	Length 010-999 ft 003-305 m			

MPO16 singlemode APC patch cords

1 U	2 Q	3 G	4 R	5 P	6 R	7 P	8 7	9 R	10 -	11 J	12 A	13 F	14-16 003
Construction type U Ultra-low loss	Cable family Q Plenum Array R Dual Rated (OFNR/LSZH)	Fiber type G Singlemode (AZ)	Connector 1 RP 16f MPO SM APC (Non-Pinned)	Connector 2 RP 16f MPO SM APC (Non-Pinned)	Cordage size 7 16f PmP Array Cord, 3mm	Fiber count R 16-fiber	Color J Yellow	Breakout length A No gland	UOM F Feet M Meter	Length 003-999 ft 001-305 m			

800GBASE-DR8+ to 800GBASE-DR8+ (2 km)
800GBASE-DR8 to 800GBASE-DR8 (500m)

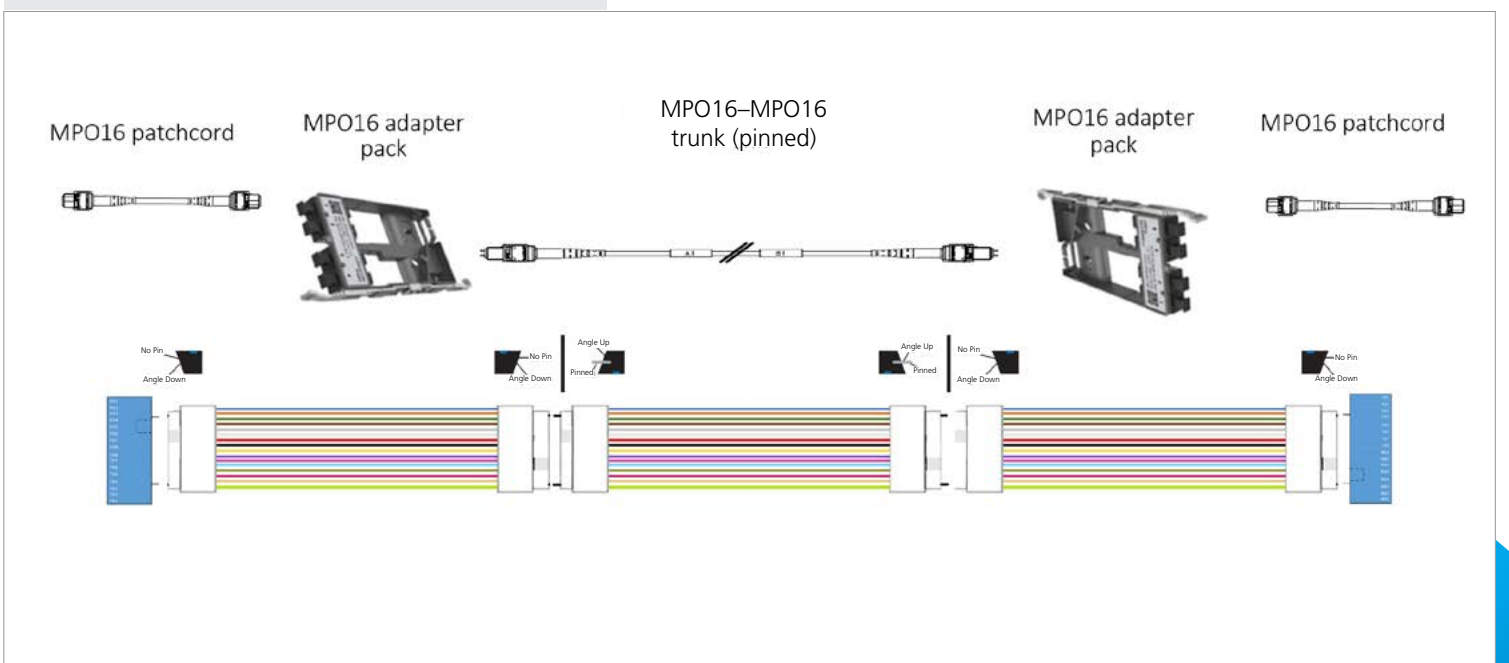

	Material ID	Product Number	Description	Fiber Type	Fiber Count	Front Interface	Rear Interface
16-fiber adapter packs							
9 per 1RU	760252804	PPL-AP-8-MPO16-ALL-B	Propel pass-through adapter pack, Type B	All	128	8 MPO16 Key Up with dust caps	8 MPO16 Key Up with dust caps
18 per 1 RU	760252806	PPL-AP-4-MPO16-ALL-B	Propel pass-through adapter pack, Type B	All	64	4 MPO16 Key Up with dust caps	4 MPO16 Key Up with dust caps
12 per 1 RU	760252805	PPL-AP-6-MPO16-ALL-B	Propel pass-through adapter pack, Type B	All	96	6 MPO16 Key Up with dust caps	6 MPO16 Key Up with dust caps
6 per 1RU	760252803	PPL-AP-12-MPO16-ALL-B	Propel pass-through adapter pack, Type B	All	192	12 MPO16 Key Up with dust caps	12 MPO16 Key Up with dust caps

For panel ordering information, refer to panel annex in the back of this guide.

MPO16 singlemode APC assemblies

MPO16 singlemode APC trunk cables

1 U	2 G	3 G	4 R	5 X	6 R	7 X	8 8	9 R	10 -	11 J	12 J	13 F	14-16 010
Construction type U Ultra-low loss	Cable family 3 Trunk, LSZH CPR B2ca G Trunk, Plenum J Trunk, Dual Rated (OFNR/LSZH)	Fiber type G Singlemode (AZ)	Connector 1 RX 16f MPO SM APC (Pinned)	Connector 2 RX 16f MPO SM APC (Pinned)	Cordage size 8 16f PmP Trunk, 3.0mm SU	Fiber count R 16-fiber S 32-fiber H 48-fiber U 64-fiber L 96-fiber Q 128-fiber M 144-fiber N 192-fiber	Color J Yellow	Breakout length J 22" Break Propel No Pull Grip K 22" Break Propel Pull Grip	UOM F Feet M Meter	Length 010-999 ft 003-305 m			

MPO16 singlemode APC patch cords

1 U	2 Q	3 G	4 R	5 P	6 R	7 P	8 7	9 R	10 -	11 J	12 A	13 F	14-16 003
Construction type U Ultra-low loss	Cable family Q Plenum Array R Dual Rated (OFNR/LSZH)	Fiber type G Singlemode (AZ)	Connector 1 RP 16f MPO SM APC (Non-Pinned)	Connector 2 RP 16f MPO SM APC (Non-Pinned)	Cordage size 7 16f PmP Array Cord, 3mm	Fiber count R 16-fiber	Color J Yellow	Breakout length A No gland	UOM F Feet M Meter	Length 003-999 ft 001-305 m			

SYSTIMAX Uniboot patch cords

1 U	2 D	3 G	4 L	5 U	6 6	7 2	8 -	9 X	10 F	11-12 010
Construction type U Ultra-low loss	Cable family D Plenum F LSZH/Riser	Fiber type G Singlemode (AZ)	Connector 1 LU LC Uniboot	Connector 2 LU LC Uniboot	Cordage size K 1.5 mm 6 2.0 mm	Fiber count 2 2-fiber	Color J Yellow	Breakout length X No breakout	UOM F Feet M Meter	Length 2-200 Feet 1-061 Meters

• Other lengths available please contact CommScope

	Material ID	Product Number	Description	Fiber Type	Fiber Count	Front Interface	Rear Interface
16-fiber adapter packs							
9 per 1RU	760252804	PPL-AP-8-MPO16-ALL-B	Propel pass-through adapter pack, Type B	All	128	8 MPO16 Key Up with dust caps	8 MPO16 Key Up with dust caps
18 per 1RU	760252806	PPL-AP-4-MPO16-ALL-B	Propel pass-through adapter pack, Type B	All	64	4 MPO16 Key Up with dust caps	4 MPO16 Key Up with dust caps
12 per 1RU	760252805	PPL-AP-6-MPO16-ALL-B	Propel pass-through adapter pack, Type B	All	96	6 MPO16 Key Up with dust caps	6 MPO16 Key Up with dust caps
6 per 1RU	760252803	PPL-AP-12-MPO16-ALL-B	Propel pass-through adapter pack, Type B	All	192	12 MPO16 Key Up with dust caps	12 MPO16 Key Up with dust caps

400GBASE-DR8 to 8x50GBASE-DR (500m)
800GBASE-DR8 to 8x100GBASE-DR (500m)

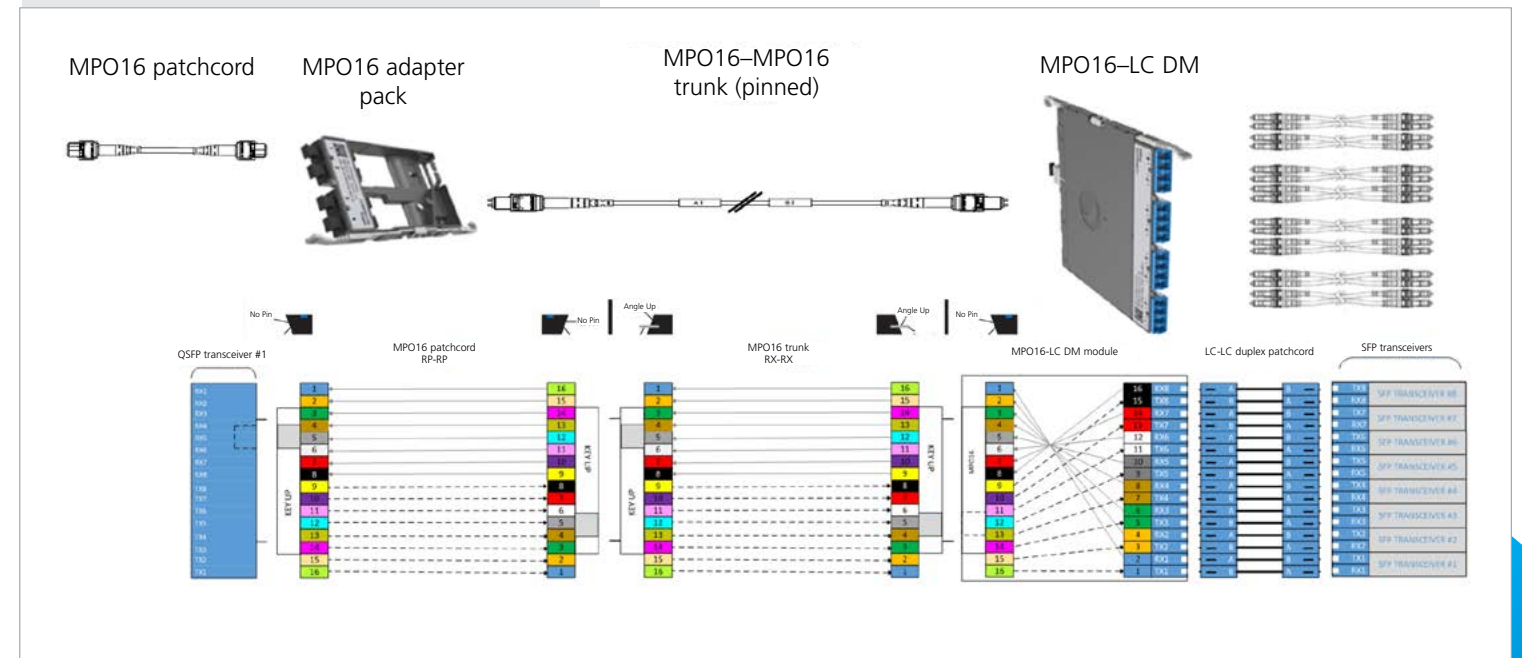

For panel ordering information, refer to panel annex in the back of this guide.

MPO16 singlemode APC assemblies

MPO16 singlemode APC trunk cables

1 U	2 G	3 G	4 R	5 X	6 R	7 X	8 8	9 R	10 -	11 J	12 J	13 F	14-16 010
Construction type U Ultra-low loss	Cable family 3 Trunk, LSZH CPR B2ca G Trunk, Plenum J Trunk, Dual Rated (OFNR/LSZH)	Fiber type G Singlemode (AZ)	Connector 1 RX 16f MPO SM APC (Pinned)	Connector 2 RX 16f MPO SM APC (Pinned)	Cordage size 8 16f PmP Trunk, 3.0mm SU	Fiber count R 16-fiber S 32-fiber H 48-fiber U 64-fiber L 96-fiber Q 128-fiber M 144-fiber N 192-fiber	Color J Yellow	Breakout length J 22" Break Propel No Pull Grip K 22" Break Propel Pull Grip	UOM F Feet M Meter	Length 010-999 ft 003-305 m			

MPO16 singlemode APC patch cords

1 U	2 Q	3 G	4 R	5 P	6 R	7 P	8 7	9 R	10 -	11 J	12 A	13 F	14-16 003
Construction type U Ultra-low loss	Cable family Q Plenum Array R Dual Rated (OFNR/LSZH)	Fiber type G Singlemode (AZ)	Connector 1 RP 16f MPO SM APC (Non-Pinned)	Connector 2 RP 16f MPO SM APC (Non-Pinned)	Cordage size 7 16f PmP Array Cord, 3mm	Fiber count R 16-fiber	Color J Yellow	Breakout length A No gland	UOM F Feet M Meter	Length 003-999 ft 001-305 m			

MPO16 singlemode APC conversion array cords

1 U	2 Q	3 G	4 R	5 P	6 Q	7 P	8 7	9 R	10 -	11 J	12 D	13 F	14-16 003
Construction type U Ultra-low loss	Cable family Q Plenum Array R Dual Rated (OFNR/LSZH)	Fiber type G Singlemode (AZ)	Connector 1 RP 16f MPO SM APC (Non-Pinned)	Connector 2 QP 8f MPO SM APC (Non-Pinned)	Cordage size 7 16f PmP Array Cord, 3mm	Fiber count R 16-fiber	Color J Yellow	Breakout length D 12" E 24" H 48" L 72"	UOM F Feet M Meter	Length 12 in 3-999 ft 24 in 4-999 ft 48 in 6-999 ft 72 in 8-999 ft 12 in 1-305 m 24-48 in 2-305 m 72 in 3-305 m			

800GBASE-DR8 to 2x400GBASE-DR4 (500m)

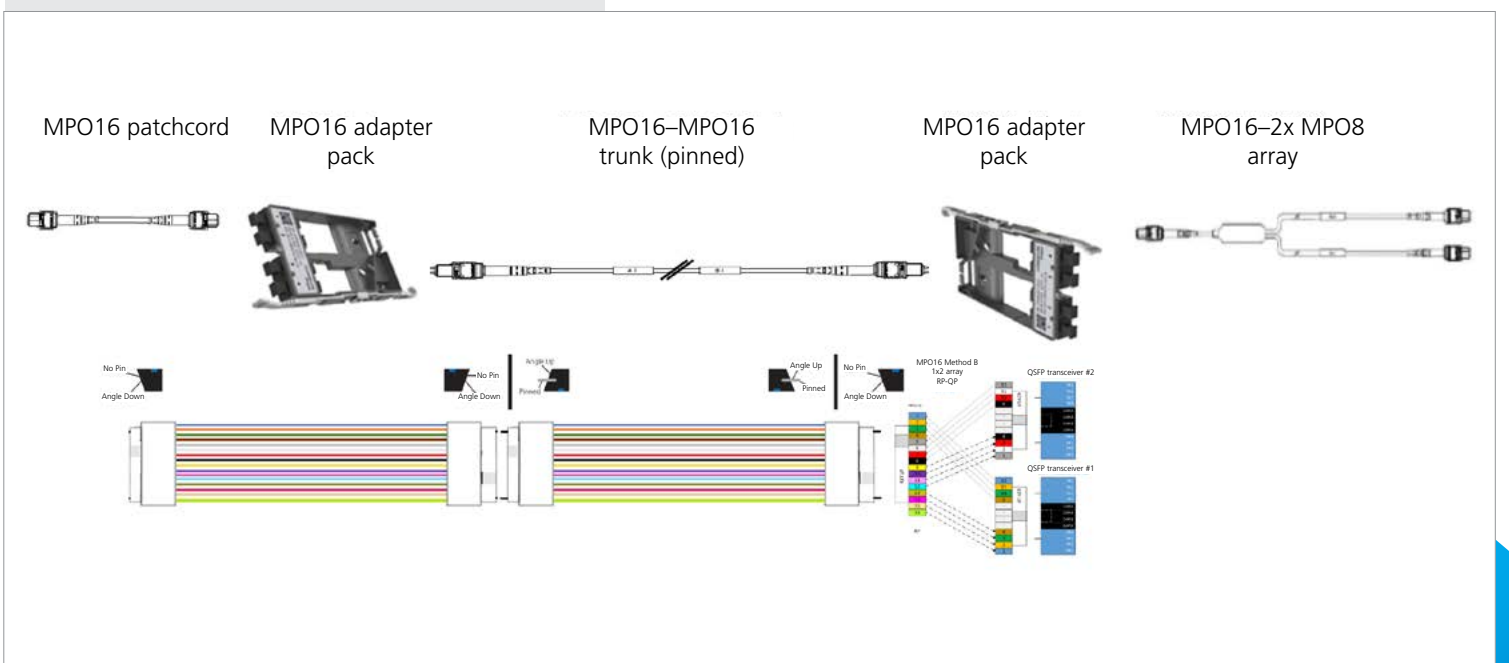

	Material ID	Product Number	Description	Fiber Type	Fiber Count	Front Interface	Rear Interface
16-fiber adapter packs							
9 per 1RU	760252804	PPL-AP-8-MPO16-ALL-B	Propel pass-through adapter pack, Type B	All	128	8 MPO16 Key Up with dust caps	8 MPO16 Key Up with dust caps
18 per 1RU	760252806	PPL-AP-4-MPO16-ALL-B	Propel pass-through adapter pack, Type B	All	64	4 MPO16 Key Up with dust caps	4 MPO16 Key Up with dust caps
12 per 1RU	760252805	PPL-AP-6-MPO16-ALL-B	Propel pass-through adapter pack, Type B	All	96	6 MPO16 Key Up with dust caps	6 MPO16 Key Up with dust caps
6 per 1RU	760252803	PPL-AP-12-MPO16-ALL-B	Propel pass-through adapter pack, Type B	All	192	12 MPO16 Key Up with dust caps	12 MPO16 Key Up with dust caps

For panel ordering information, refer to panel annex in the back of this guide.

MPO16 Basic Channel

MPO16 APC basic channels

Propel MPO16 ULL Multimode OM4/OM5 Method B Enhanced Polarity – LC Duplex BASE

MPO16-MPO16 APC trunk (pinned) CommScope MP cable fiber counts 16, 32, 48, 96, 128, 144, 192

Supports duplex applications

LC Uniboot

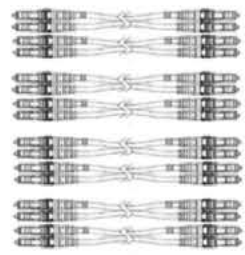

MPO16-LC DM
3/blade 9/RU



MPO16-LC DM
3/blade 9/RU



LC Uniboot

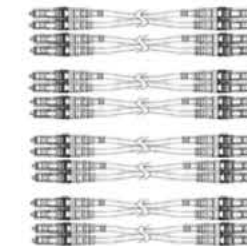

Supports SR8 applications over duplex base design

MPO16 to LC Uniboot

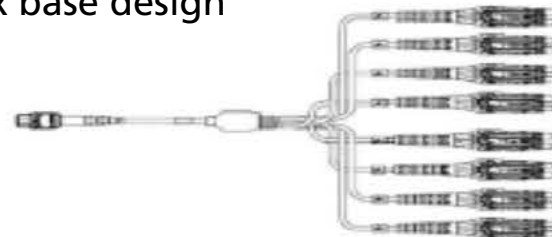

MPO16-LC DM



MPO16-LC DM



LC Uniboot to MPO16

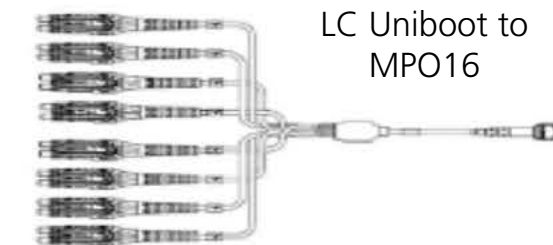

Supports QSFP 4 pr including BiDi applications over duplex base design

MPO8 to LC Uniboot

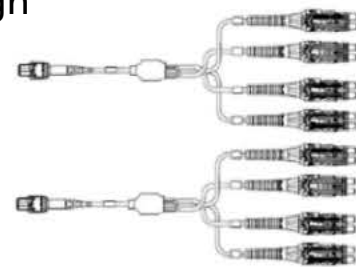

MPO16-LC DM



MPO16-LC DM



LC Uniboot to MPO8



Note: Above scenarios can be mixed if application supports breakout lanes

MPO16 APC basic channels

Propel MPO16 ULL Multimode OM4/OM5 Method B Enhanced Polarity – MPO Adapter BASE

MPO16-MPO16 APC trunk (pinned) CommScope MP cable fiber counts 16, 32, 48, 96, 128, 144, 192

MPO16 offset key
adapter pack

MPO16 offset key
adapter pack

Supports SR8
applications

MPO16 to MPO16
APC non-pinned



MPO16 to MPO16
non-pinned



Supports SR8 to 2 QSFP
applicatios (for 400G SR4
use MJPO8 APC)



MPO16 to MPO16
non-pinned



Supports SR8 to 8xSR
applications



MPO16 to LC
Uniboot

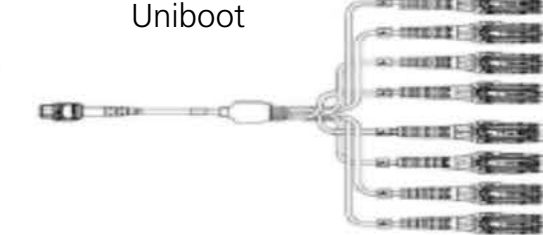

Supports QSFP 4 pr applications

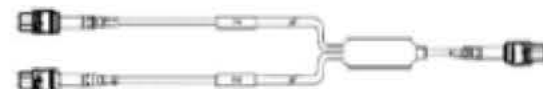

MPO16 to MPO8
UPCx2 non-pinned



Note: Above scenarios can be mixed if application supports breakout lanes

MPO16 APC basic channels

Propel MPO16 ULL Singlemode Method B Enhanced Polarity – LC Duplex BASE

MPO16-MPO16 APC trunk (pinned)
CommScope MP cable fiber counts
16, 32, 48, 96, 128, 144, 192

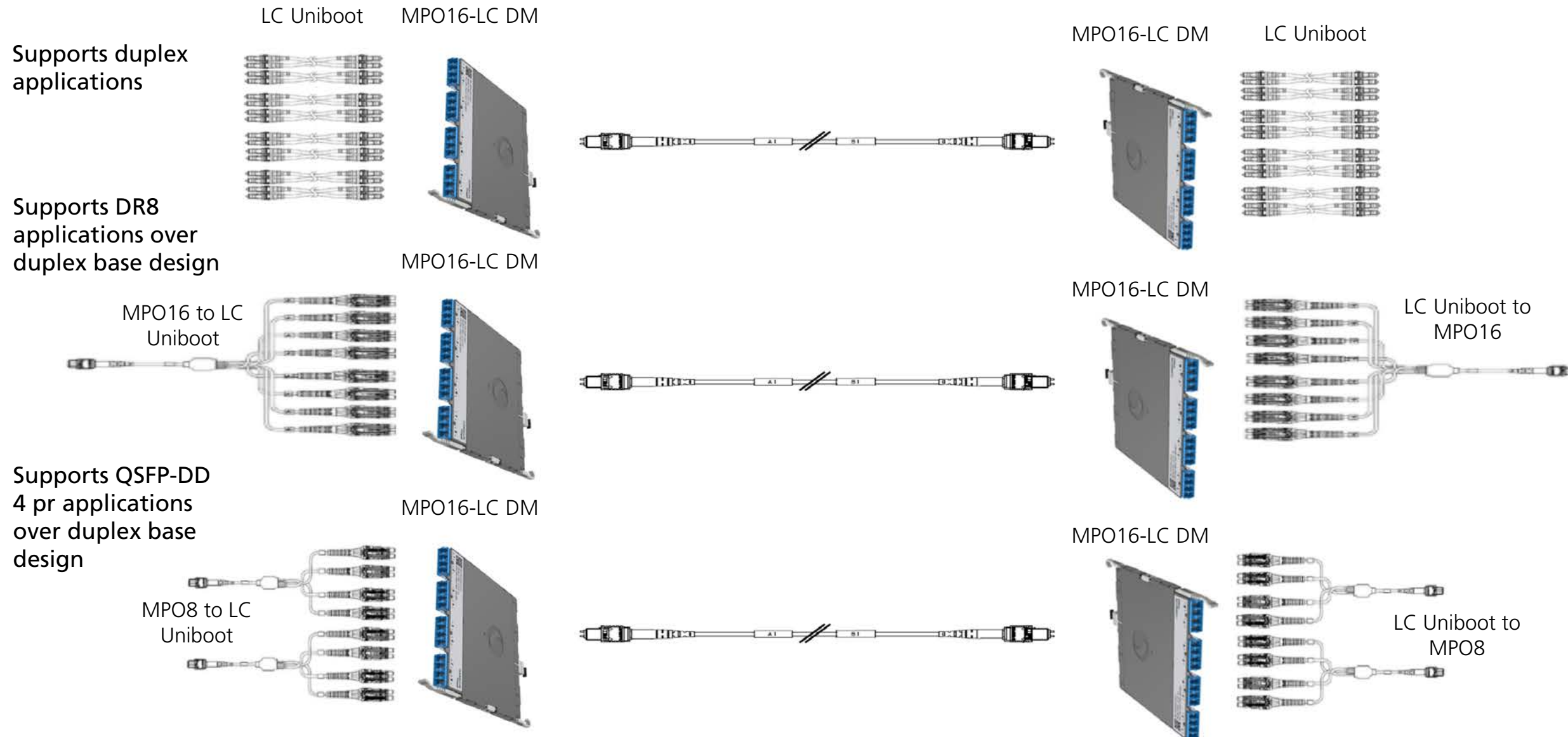

Note: Above scenarios can be mixed if application supports breakout lanes

MPO16 APC basic channels

Propel MPO16 ULL Singlemode APC Method B Enhanced Polarity – MPO Adapter BASE

MPO16-MPO16 APC trunk (pinned) CommScope MP cable fiber counts 16, 32, 48, 96, 128, 144, 192

Supports DR8 applications

MPO16 to MPO16 APC non-pinned



MPO16 offset key adapter pack



MPO16 offset key adapter pack



MPO16 to MPO16 non-pinned



Supports DR8 tp 2xDR4 QSFP-DD applications



MPO16 to MPO8x2 non-pinned



Supports DR8 tp 8xDR applications



MPO16 to LC Uniboot

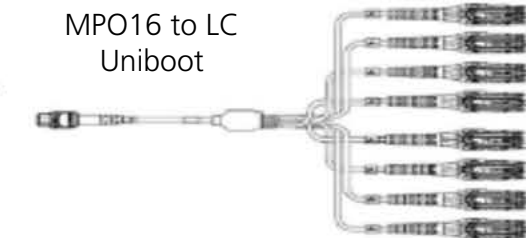

Supports 2 QSFP/QSFP-DD 4 pr applications. Eg: DR4



MPO16 to MPO8x2 non-pinned



Note: Above scenarios can be mixed if application supports breakout lanes

MPO16 APC basic channels

Propel MPO16 ULL Singlemode Method B Enhanced Polarity – SN

Supports high-density duplex applications:
144SN/288 fibers per RU

MPO16-MPO16 APC trunk (pinned)
CommScope MP cable fiber counts
16, 32, 48, 96, 128, 144, 192

LC Uniboot to SN
patch cord x2

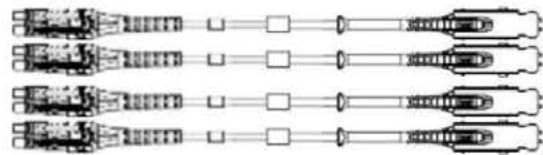

MPO16-SN DM
6/blade 18/RU



MPO16-SN DM
6/blade 18/RU



SN to LC Uniboot
patch cord x2

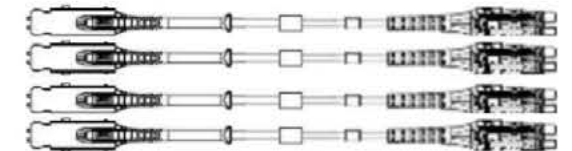

SN to SN patch
cord



Will support high-density duplex applications:
144SN/288 fiber per RU
Can be used for high-density cross-connect or equipment
cords as transceivers become market available

Note: Above scenarios can be mixed if application supports breakout lanes

MPO8 Solutions

MPO8 OM4/OM5 multimode UPC assemblies

MPO8 multimode UPC trunk cables

1 U	2 G	3 X	4 Q	5 Z	6 Q	7 Z	8 T	9 8	10 -	11 M	12 J	13 F	14-16 010
Construction type U Ultra-low loss	Cable family 3 Trunk, LSZH CPR B2ca G Trunk, Plenum J Trunk, Dual Rated (OFNR/LSZH)	Fiber type X OM4 multimode V OM5 WB multimode	Connector 1 QZ 8f MPO MM UPC (Pinned)	Connector 2 QZ 8f MPO MM UPC (Pinned)	Cordage size T 8f PmP Trunk, 2.0mm SU	Fiber count R 8-fiber S 16-fiber F 24-fiber S 32-fiber H 48-fiber U 64-fiber K 72-fiber L 96-fiber M 144-fiber N 192-fiber	Color M OM4 Aqua N OM5 Lime green	Breakout length J 22" Break Propel No Pull Grip K 22" Break Propel Pull Grip	UOM F Feet M Meter	Length 010-999 ft 003-305 m			

MPO8 multimode UPC patch cords

1 U	2 Q	3 X	4 Q	5 V	6 Q	7 V	8 F	9 8	10 -	11 M	12 A	13 F	14-16 010
Construction type U Ultra-low loss	Cable family Q Plenum Array R Dual Rated (OFNR/LSZH)	Fiber type X OM4 multimode V OM5 WB multimode	Connector 1 QV 8f MPO MM UPC (Non-pinned)	Connector 2 QV 8f MPO MM UPC (Non-pinned)	Cordage size F 8f PmP Array Cord, 2mm	Fiber count 8 8-fiber	Color M OM4 Aqua N OM5 Lime green	Breakout length A No Gland	UOM F Feet M Meter	Length 003-999 ft 001-305 m			

40GBASE-SR4 to 40GBASE-SR4 (100m-OM4, 150m-OM5)
 100GBASE-SR4 to 100GBASE-SR4 (100m-OM4, 150m-OM5)
 400GBASE-SR4.2 to 400GBASE-SR4.2 (BiDi) (100m-OM4, 150m-OM5)
 800GBASE-SR4.2 to 800GBASE-SR4.2 (BiDi) (MSA) (100m-OM4, 150m-OM5)

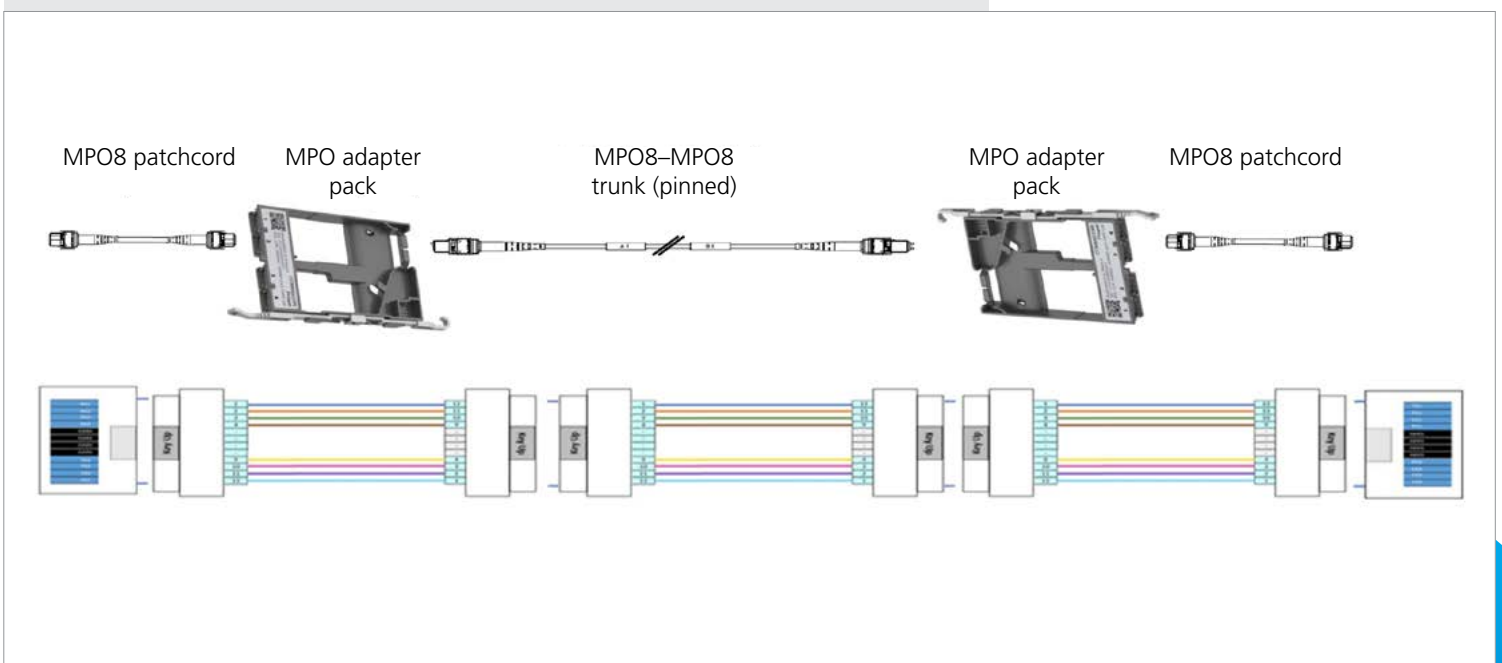

Material ID	Product Number	Description	Fiber Type	Fiber Count	Front Interface	Rear Interface
8-fiber adapter packs						
18 per 1RU	760252371	PPL-AP-4-MPO-ALL-B	Propel pass-through adapter pack, Type B	All	32	4 MPO8 Key Up with internal shutters / 4 MPO8 Key Up with dust caps

For panel ordering information, refer to panel annex in the back of this guide.

MPO8 OM4/OM5 multimode UPC assemblies

MPO8 multimode UPC trunk cables

1	2	3	4	5	6	7	8	9	10	11	12	13	14-16
U	G	X	Q	X	Q	X	T	8	-	M	J	F	010
Construction type U Ultra-low loss	Cable family 3 Trunk, LSZH CPR B2ca G Trunk, Plenum J Trunk, Dual Rated (OFNR/LSZH)	Fiber type X OM4 multimode V OM5 WB multimode	Connector 1 QX 8f MPO MM UPC (Pinned)	Connector 2 QX 8f MPO MM UPC (Pinned)	Cordage size T 8f PmP Trunk, 2.0mm SU	Fiber count 8 8-fiber R 16-fiber S 24-fiber H 48-fiber U 64-fiber K 72-fiber L 96-fiber M 144-fiber N 192-fiber	Color M OM4 Aqua N OM5 Lime green	Breakout length J 22" Break Propel No Pull Grip K 22" Break Propel Pull Grip	UOM F Feet M Meter	Length 010-999 ft 003-305 m			

MPO8 multimode UPC patch cords

1	2	3	4	5	6	7	8	9	10	11	12	13	14-16
U	Q	X	Q	P	Q	P	F	8	-	M	A	F	010
Construction type U Ultra-low loss	Cable family Q Plenum Array R Dual Rated (OFNR/LSZH)	Fiber type X OM4 multimode V OM5 WB multimode	Connector 1 QP 8f MPO MM UPC (Non-pinned)	Connector 2 QP 8f MPO MM UPC (Non-pinned)	Cordage size F 8f PmP Array Cord, 2mm	Fiber count 8 8-fiber	Color M OM4 Aqua N OM5 Lime green	Breakout length A No Gland	UOM F Feet M Meter	Length 003-999 ft 001-305 m			

MPO8 multimode UPC array cords

1	2	3	4	5	6	7	8	9	10	11	12	13	14-16
U	Q	X	Q	P	L	U	F	8	-	M	D	F	010
Construction type U Ultra-low loss	Cable family Q Plenum Array R Dual Rated (OFNR/LSZH)	Fiber type X OM4 multimode V OM5 WB multimode	Connector 1 QP 8f MPO MM UPC (Non-pinned)	Connector 2 LU LC Uniboot	Cordage size F 8f PmP Array Cord, 2mm	Fiber count 8 8-fiber	Color M OM4 Aqua N OM5 Lime green	Breakout length D 12" E 24" H 48" L 72"	UOM F Feet M Meter	Length 12 in 3-999 ft 24 in 4-999 ft 48 in 6-999 ft 72 in 8-999 ft 12 in 1-305 m 24-48 in 2-305 m 72 in 3-305 m			

SYSTIMAX Uniboot patch cords

1	2	3	4	5	6	7	8	9	10	11-12
U	D	X	L	U	6	2	-	X	F	010
Construction type U Ultra-low loss	Cable family D Plenum F LSZH/Riser	Fiber type X OM4 multimode V OM5 WB multimode	Connector 1 LU LC Uniboot	Connector 2 LU LC Uniboot	Cordage size K 1.5 mm 6 2.0 mm	Fiber count 2 2-fiber	Color M OM4 Aqua N OM5 Lime green	Breakout length X No breakout	UOM F Feet M Meter	Length 2-200 Feet 1-061 Meters

• Other lengths available please contact CommScope

	Material ID	Product Number	Description	Fiber Type	Fiber Count	Front Interface	Rear Interface
MPO8 Modules with MPO/UPC in multimode							
18 per 1RU	760252332	PPL-DM-8U-8LC-OM4-BEU	Propel ULL Distribution Module, Method B Enhanced	OM4	8	4 duplex LCs with internal shutters	1 MPO8 non-pinned with internal shutter
	760252333	PPL-DM-8U-8LC-OM5-BEU	Propel ULL Distribution Module, Method B Enhanced	OM5	8	4 duplex LCs with internal shutters	1 MPO8 non-pinned with internal shutter
8-fiber adapter packs							
18 per 1RU	760252371	PPL-AP-4-MPO-ALL-B	Propel pass-through adapter pack, Type B	All	32	4 MPO8 Key Up with internal shutters	4 MPO8 Key Up with dust caps

40GBASE-SR4 to 4x10GBASE-SR (150m)
100GBASE-SR4 to 4x25GBASE-SR (100m)

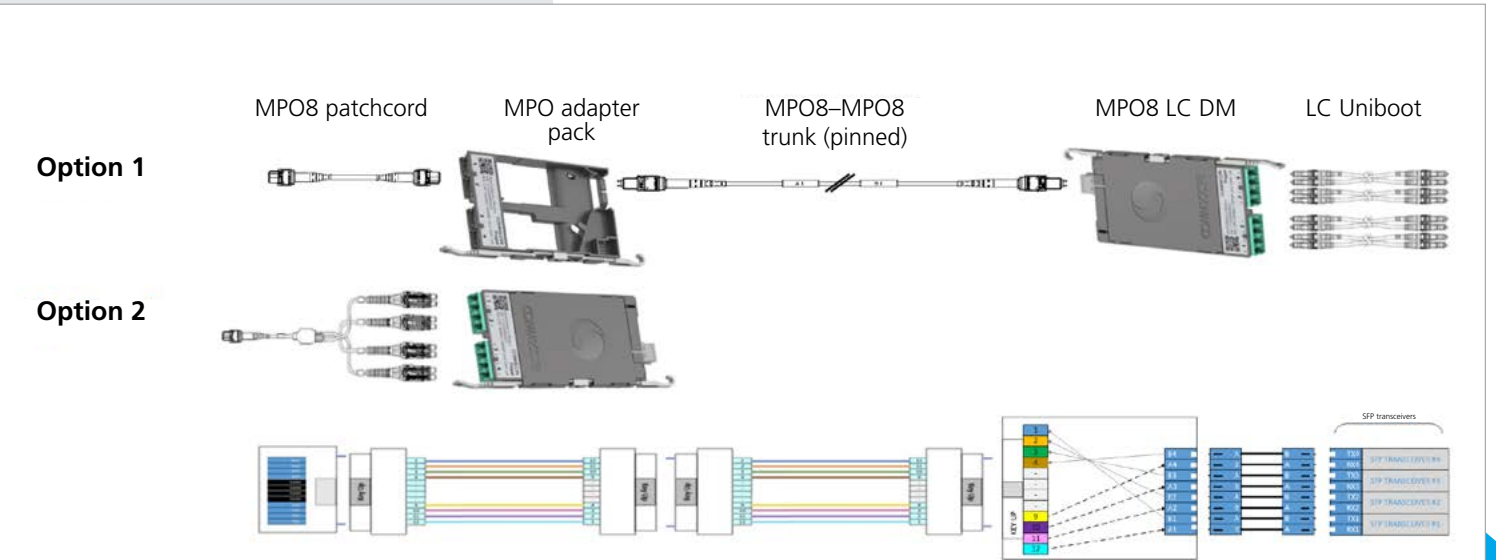

For panel ordering information, refer to panel annex in the back of this guide.

MPO8 singlemode APC assemblies

MPO8 singlemode APC trunk cables

1 U	2 G	3 G	4 Q	5 X	6 Q	7 X	8 T	9 8	10 -	11 J	12 J	13 F	14-16 010
Construction type U Ultra-low loss	Cable family 3 Trunk, LSZH CPR B2ca G Trunk, Plenum J Trunk, Dual Rated (OFNR/LSZH)	Fiber type G Singlemode (A2)	Connector 1 QX 8f MPO SM APC (Pinned)	Connector 2 QX 8f MPO SM APC (Pinned)	Cordage size T 8f PmP Trunk, 2.0mm SU	Fiber count 8 8-fiber R 16-fiber F 24-fiber S 32-fiber H 48-fiber U 64-fiber K 72-fiber L 96-fiber M 144-fiber N 192-fiber	Color J Yellow	Breakout length J 22" Break Propel No Pull Grip K 22" Break Propel Pull Grip	UOM F Feet M Meter	Length 010-999 ft 003-305 m			

MPO8 singlemode APC patch cord

1 U	2 Q	3 G	4 Q	5 P	6 Q	7 P	8 F	9 8	10 -	11 J	12 A	13 F	14-16 010
Construction type U Ultra-low loss	Cable family Q Plenum Array R Dual Rated (OFNR/LSZH)	Fiber type G Singlemode (A2)	Connector 1 QP 8f MPO SM APC (Non-pinned)	Connector 2 QP 8f MPO SM APC (Non-pinned)	Cordage size F 8f PmP Array Cord, 2mm	Fiber count 8 8-fiber	Color J Yellow	Breakout length A No Gland	UOM F Feet M Meter	Length 003-999 ft 001-305 m			

SYSTIMAX Uniboot patch cords

1 U	2 D	3 G	4 L	5 U	6 6	7 2	8 -	9 J	10 X	11-12 010
Construction type U Ultra-low loss	Cable family D Plenum F LSZH/Riser	Fiber type G Singlemode (A2)	Connector 1 LU LC Uniboot	Connector 2 LU LC Uniboot	Cordage size K 1.5 mm 6 2.0 mm	Fiber count 2 2-fiber	Color J Yellow	Breakout length X No breakout	UOM F Feet M Meter	Length 2-200 Feet 1-061 Meters

• Other lengths available please contact CommScope

	Material ID	Product Number	Description	Fiber Type	Fiber Count	Front Interface	Rear Interface
MPO8 Modules with MPO in singlemode							
18 per 1RU	760252334	PPL-DM-8AU-8LC-SM-BEU	Propel ULL Distribution Module, Method B Enhanced	OS2	8	4 duplex LCs with internal shutters	1 MPO8/APC non-pinned with internal shutter
8-fiber adapter packs							
18 per 1RU	760252371	PPL-AP-4-MPO-ALL-B	Propel pass-through adapter pack, Type B	All	32	4 MPO8 Key Up with internal shutters	4 MPO8 Key Up with dust caps

400GBASE-DR4 to 4x100GBASE-DR (500m)

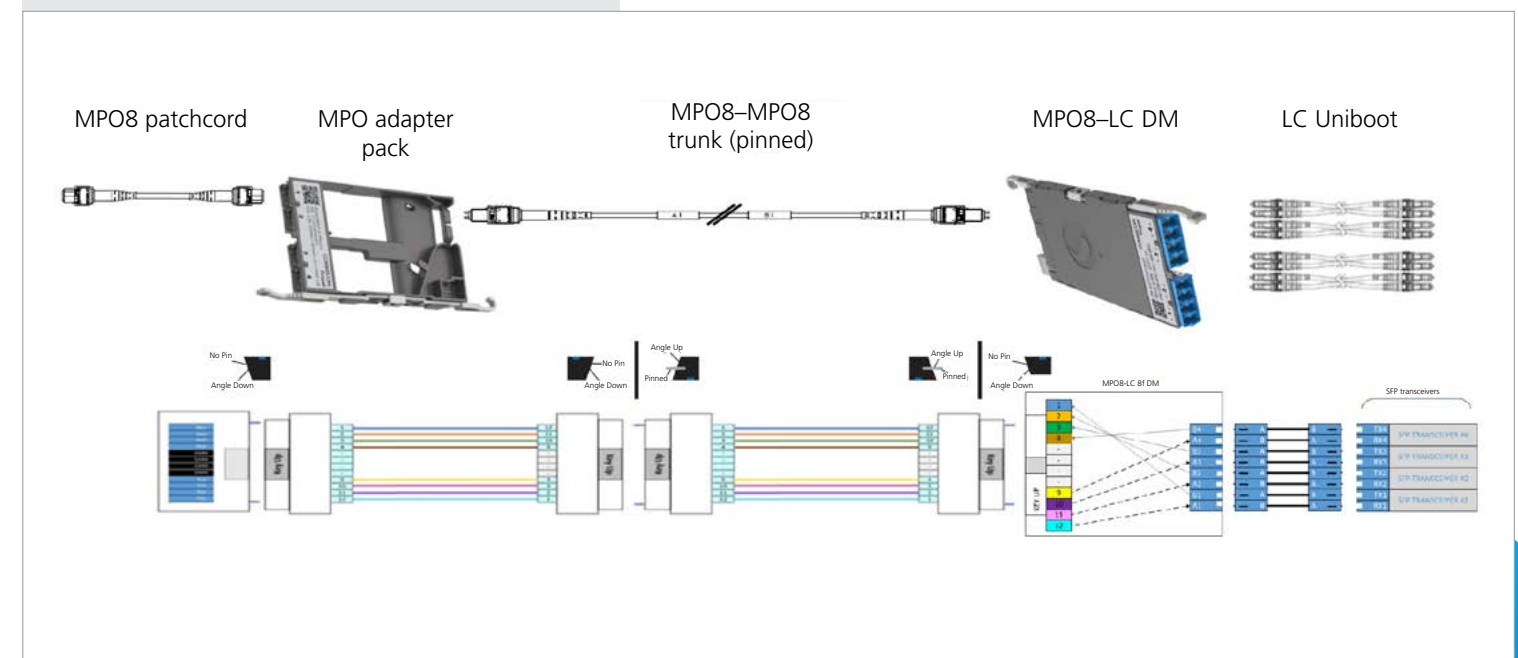

For panel ordering information, refer to panel annex in the back of this guide.

MPO8 OM4/OM5 multimode APC assemblies

MPO8 multimode APC trunk cables

1 U	2 G	3 X	4 Q	5 Z	6 Q	7 Z	8 T	9 8	10 -	11 M	12 K	13 F	14-16 010
Construction type U Ultra-low loss	Cable family 3 Trunk, LSZH CPR B2ca G Trunk, Plenum J Trunk, Dual Rated (OFNR/LSZH)	Fiber type X OM4 multimode V OM5 WB multimode	Connector 1 QZ 8f MPO MM APC (Pinned)	Connector 2 QZ 8f MPO MM APC (Pinned)	Cordage size T 8f PmP Trunk, 2.0mm SU	Fiber count 8 8-fiber R 16-fiber F 24-fiber S 32-fiber H 48-fiber U 64-fiber K 72-fiber L 96-fiber M 144-fiber N 192-fiber	Color M OM4 Aqua N OM5 Lime green	Breakout length K 22" Break Propel No Pull Grip	UOM F Feet M Meter	Length 010-999 ft 003-305 m			

MPO8 multimode APC patch cords

1 U	2 Q	3 X	4 Q	5 V	6 Q	7 V	8 F	9 8	10 -	11 M	12 A	13 F	14-16 010
Construction type U Ultra-low loss	Cable family Q Plenum Array R Dual Rated (OFNR/LSZH)	Fiber type X OM4 multimode V OM5 WB multimode	Connector 1 QV 8f MPO MM APC (Non-pinned)	Connector 2 QV 8f MPO MM APC (Non-pinned)	Cordage size F 8f PmP Array Cord, 2mm	Fiber count 8 8-fiber	Color M OM4 Aqua N OM5 Lime green	Breakout length A No Gland	UOM F Feet M Meter	Length 003-999 ft 001-305 m			

400GBASE-SR4 to 400GBASE-SR4 APC (100m)

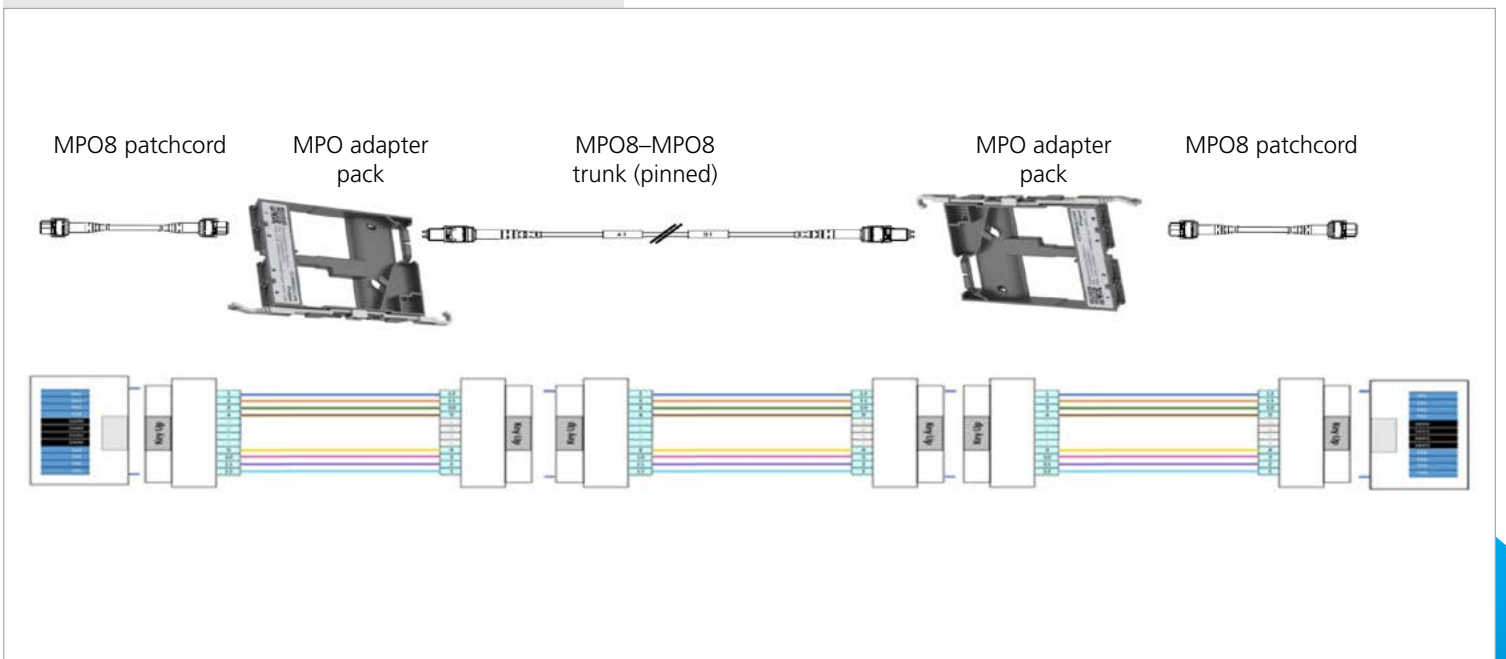

Material ID	Product Number	Description	Fiber Type	Fiber Count	Front Interface	Rear Interface	
8-fiber adapter packs							
18 per 1RU	760252371	PPL-AP-4-MPO-ALL-B	Propel pass-through adapter pack, Type B	All	32	4 MPO8 Key Up with internal shutters	4 MPO8 Key Up with dust caps

For panel ordering information, refer to panel annex in the back of this guide.

MPO8 OM4/OM5 multimode APC assemblies

MPO8 multimode APC trunk cables

1	2	3	4	5	6	7	8	9	10	11	12	13	14-16
U	G	X	Q	Z	Q	Z	T	8	-	M	K	F	010
Construction type U Ultra-low loss	Cable family 3 Trunk, LSZH CPR B2ca G Trunk, Plenum J Trunk, Dual Rated (OFNR/LSZH)	Fiber type X OM4 multimode V OM5 WB multimode	Connector 1 QZ 8f MPO MM APC (Pinned)	Connector 2 QZ 8f MPO MM APC (Pinned)	Cordage size T 8f PmP Trunk, 2.0mm SU	Fiber count 8 8-fiber R 16-fiber F 24-fiber S 32-fiber H 48-fiber U 64-fiber K 72-fiber L 96-fiber M 144-fiber N 192-fiber	Color M OM4 Aqua N OM5 Lime green	Breakout length J 22" Break Propel No Pull Grip K 22" Break Propel Pull Grip	UOM F Feet M Meter	Length 010-999 ft 003-305 m			

MPO8 multimode APC array cords

1	2	3	4	5	6	7	8	9	10	11	12	13	14-16
U	Q	X	Q	V	L	U	F	8	-	M	D	F	003
Construction type U Ultra-low loss	Cable family Q Plenum Array R Dual Rated (OFNR/LSZH)	Fiber type X OM4 multimode V OM5 WB multimode	Connector 1 QV 8f MPO MM APC (Non-pinned) QP 8f MPO MM UPC (Non-pinned)	Connector 2 LU LC Uniboot	Cordage size F 8f PmP Array Cord, 2 mm	Fiber count 8 8-fiber	Color M OM4 Aqua N OM5 Lime green	Breakout length D 12" E 24" H 48" L 72"	UOM F Feet M Meter	Length 12 in 3-999 ft 24 in 4-999 ft 48 in 6-999 ft 72 in 8-999 ft 12 in 1-305 m 24-48 in 2-305 m 72 in 3-305 m			

SYSTIMAX Uniboot patch cords

1	2	3	4	5	6	7	8	9	10	11-12
U	D	X	L	U	6	2	-	X	F	010
Construction type U Ultra-low loss	Cable family D Plenum F LSZH/Riser	Fiber type X OM4 multimode V OM5 WB multimode	Connector 1 LU LC Uniboot	Connector 2 LU LC Uniboot	Cordage size K 1.5 mm 6 2.0 mm	Fiber count 2 2-fiber	Color M OM4 Aqua N OM5 Lime green	Breakout length X No breakout	UOM F Feet M Meter	Length 2-200 Feet 1-061 Meters

• Other lengths available please contact CommScope

	Material ID	Product Number	Description	Fiber Type	Fiber Count	Front Interface	Rear Interface
MPO8 Modules with MPO/APC in multimode							
18 per 1RU	760252335	PPL-DM-8AU-8LC-OM4-BEU	Propel ULL Distribution Module, Method B Enhanced	OM4	8	4 duplex LCs with internal shutters	1 MPO8/APC non-pinned with internal shutter
	760252336	PPL-DM-8AU-8LC-OM5-BEU	Propel ULL Distribution Module, Method B Enhanced	OM5	8	4 duplex LCs with internal shutters	1 MPO8/APC non-pinned with internal shutter
8-fiber adapter packs							
18 per 1RU	760252371	PPL-AP-4-MPO-ALL-B	Propel pass-through adapter pack, Type B	All	32	4 MPO 8/12/24 Key Up with internal shutters	4 MPO 8/12/24 Key Up with dust caps

200GBASE-SR4APC to 4x50GBASE-SR (100m) 400GBASE-SR4APC to 4x100GBASE-SR1 (100m)

Note: For 200GBASE-SR4 array confirm with transceiver whether end requires APC or UPC

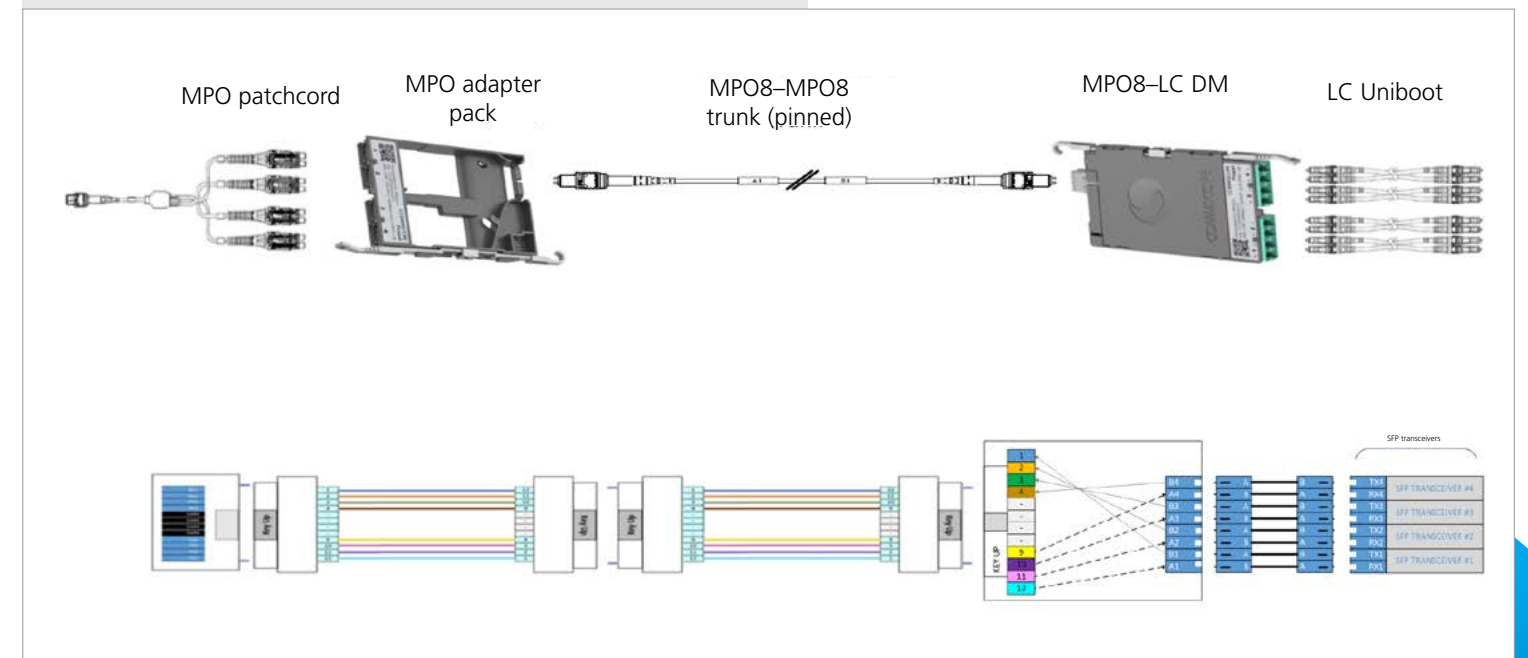

For panel ordering information, refer to panel annex in the back of this guide.

MPO8 OM4/OM5 multimode APC assemblies

MPO8 multimode APC trunk cables

1 U	2 G	3 X	4 Q	5 Z	6 Q	7 Z	8 T	9 8	10 -	11 M	12 K	13 F	14-16 010
Construction type U Ultra-low loss	Cable family 3 Trunk, LSZH CPR B2ca G Trunk, Plenum J Trunk, Dual Rated (OFNR/LSZH)	Fiber type X OM4 multimode V OM5 WB multimode	Connector 1 QZ 8f MPO MM APC (Pinned)	Connector 2 QZ 8f MPO MM APC (Pinned)	Cordage size T 8f PmP Trunk, 2.0mm SU	Fiber count 8 8-fiber R 16-fiber F 24-fiber S 32-fiber H 48-fiber U 64-fiber K 72-fiber L 96-fiber M 144-fiber N 192-fiber	Color M OM4 Aqua N OM5 Lime green	Breakout length J 22" Break Propel No Pull Grip K 22" Break Propel Pull Grip	UOM F Feet M Meter	Length 010-999 ft 003-305 m			

MPO8 multimode APC patch cords

1 U	2 Q	3 X	4 Q	5 V	6 Q	7 V	8 F	9 8	10 -	11 M	12 A	13 F	14-16 010
Construction type U Ultra-low loss	Cable family Q Plenum Array R Dual Rated (OFNR/LSZH)	Fiber type X OM4 multimode V OM5 WB multimode	Connector 1 QV 8f MPO MM APC (Non-pinned)	Connector 2 QV 8f MPO MM APC (Non-pinned)	Cordage size F 8f PmP Array Cord, 2mm	Fiber count 8 8-fiber	Color M OM4 Aqua N OM5 Lime green	Breakout length A No Gland	UOM F Feet M Meter	Length 003-999 ft 001-305 m			

MPO16 multimode APC conversion array cords

1 U	2 Q	3 X	4 R	5 V	6 Q	7 V	8 7	9 R	10 -	11 M	12 D	13 F	14-16 003
Construction type U Ultra-low loss	Cable family Q Plenum Array R Dual Rated (OFNR/LSZH)	Fiber type X OM4 multimode V OM5 WB multimode	Connector 1 RV 16f MPO MM APC (Non-Pinned)	Connector 2 QV 8f MPO MM APC (Non-Pinned)	Cordage size 7 16f PmP Array Cord, 3mm	Fiber count R 16-fiber	Color M OM4 Aqua N OM5 Lime green	Breakout length D 12" E 24" H 48" L 72"	UOM F Feet M Meter	Length 12 in 3-999 ft 24 in 4-999 ft 48 in 6-999 ft 72 in 8-999 ft 12 in 1-305 m 24-48 in 2-305 m 72 in 3-305 m			

Material ID	Product Number	Description	Fiber Type	Fiber Count	Front Interface	Rear Interface
8-fiber adapter packs						
18 per 1RU	760252371	PPL-AP-4-MPO-ALL-B	Propel pass-through adapter pack, Type B	All	32	4 MPO8 Key Up with internal shutters / 4 MPO8 Key Up with dust caps

400GBASE-SR8 to 2x200GBASE-SR4APC (100m)
800GBASE-SR8 to 2x400GBASE-SR4APC (100m)
Note: For 200GBASE-SR4 array confirm with transceiver whether end requires APC or UPC

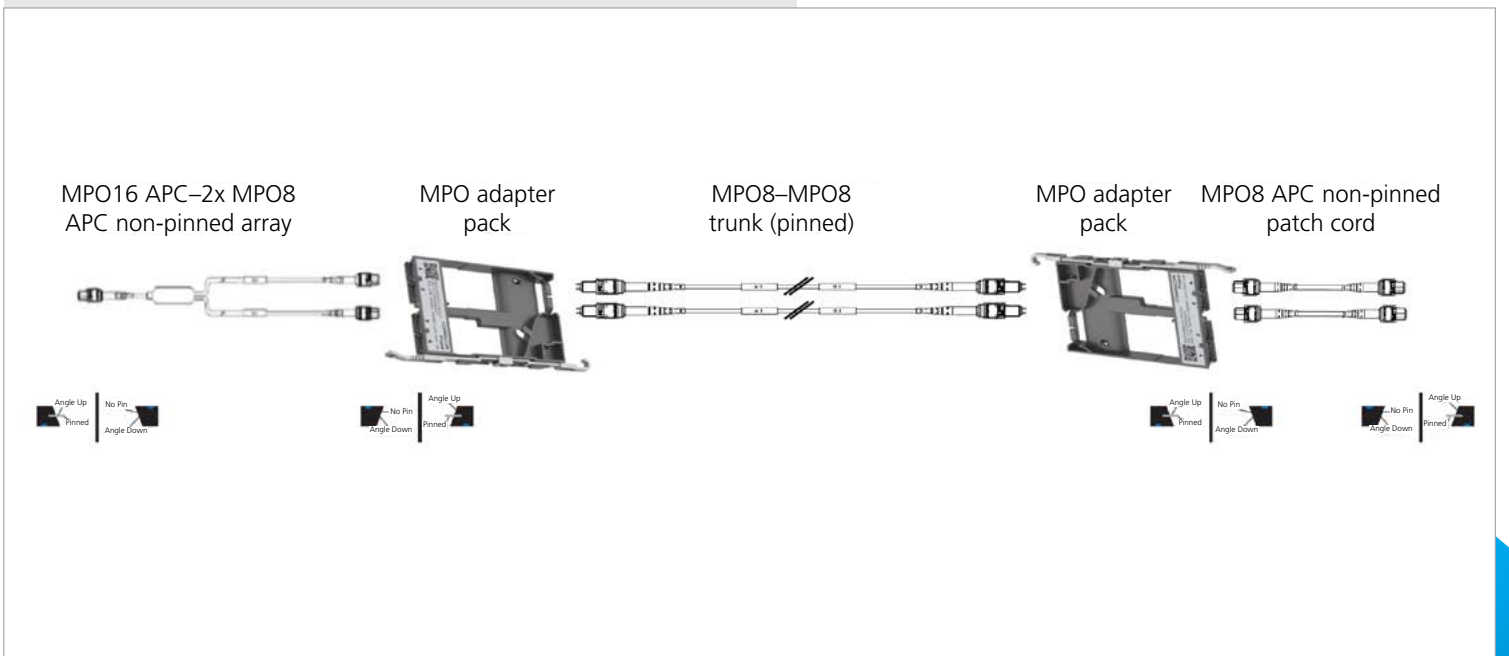

For panel ordering information, refer to panel annex in the back of this guide.

Note: MPO16 APC to 2xMPO8 APC Array cord (non-pinned) shown above can direct connect between network electronics locally

MPO8 Basic Channel

MPO8 UPC basic channels

Propel MPO8 ULL Multimode OM4/OM5 Method B Enhanced Polarity – LC Duplex BASE

MPO8-MPO8 UPC trunk (pinned)

Supports duplex applications

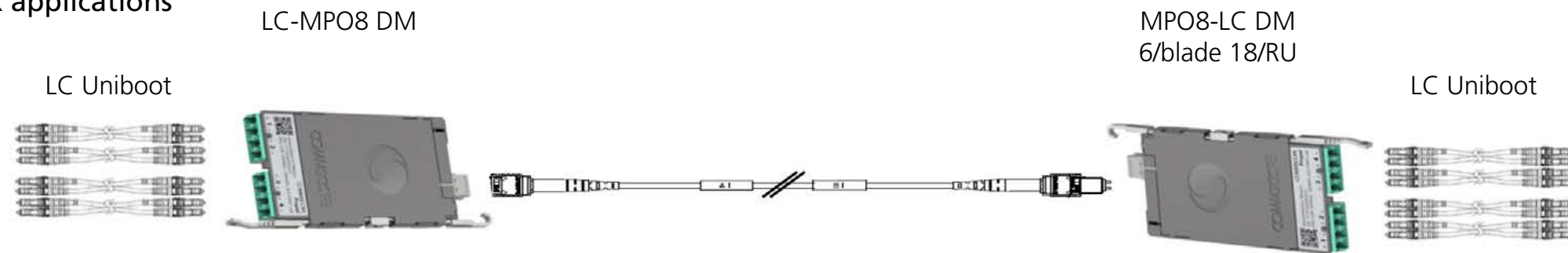

Supports SR4 applications
over duplex base design

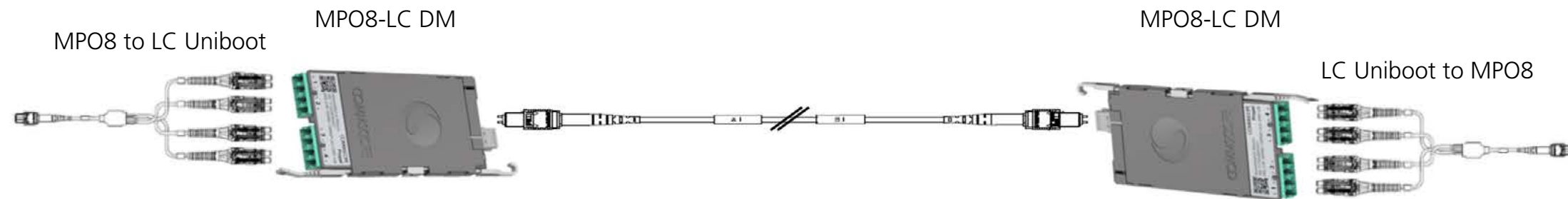

Supports QSFP 4 pr applications
over duplex base design

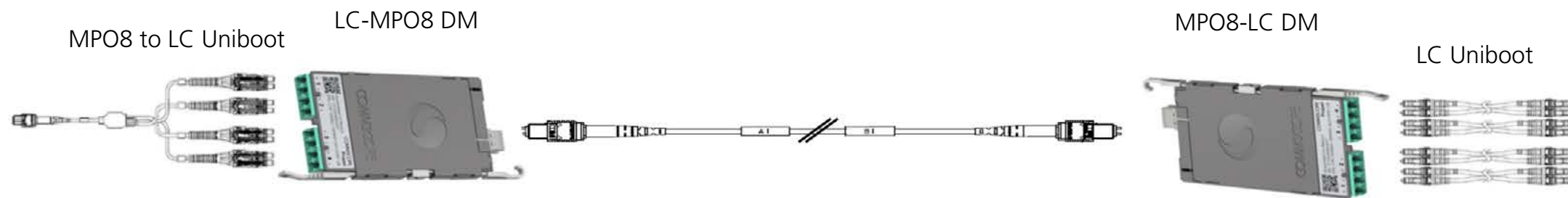

Note: Above scenarios can be mixed if application supports breakout lanes

MPO8 UPC basic channels

Propel MPO8 ULL Multimode OM4/OM5 Method B Enhanced Polarity – MPO Adapter BASE

MPO8-MPO8 UPC trunk (pinned)

Supports QSFP 4 pr applications

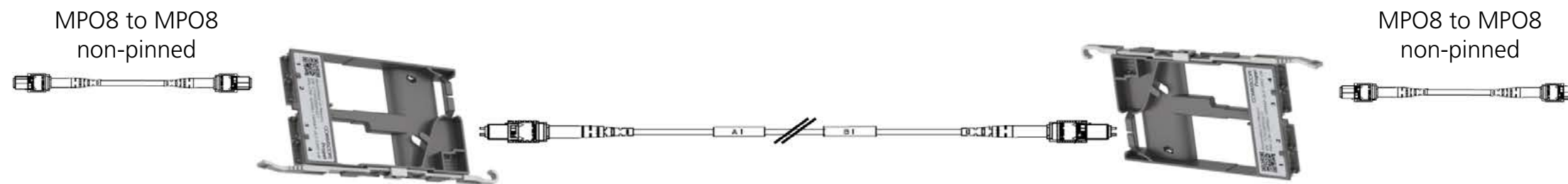

Supports QSFP 4 pr breakout applications

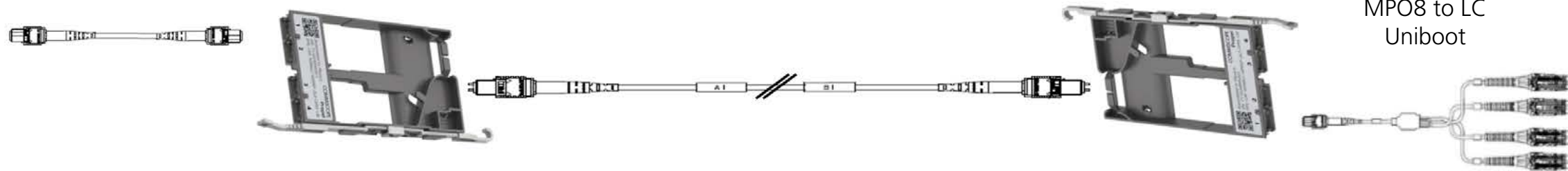

Supports QSFP 4 pr breakout applications

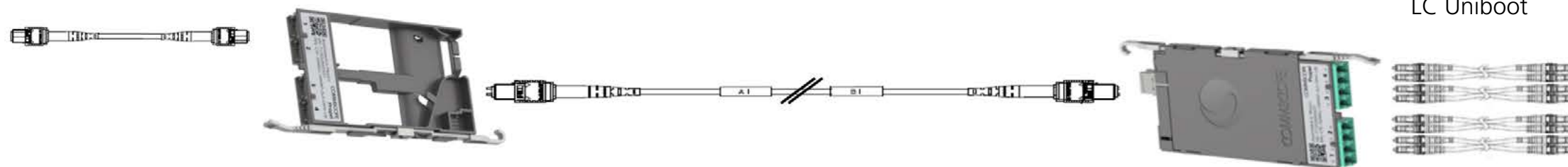

Note: Above scenarios can be mixed if application supports breakout lanes

MPO8 APC basic channels

Propel MPO8 ULL Singlemode Method B Enhanced Polarity – LC Duplex BASE

MPO8-MPO8 APC trunk (pinned)

Supports duplex applications

LC Uniboot

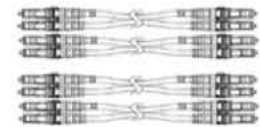

MPO8-LC DM
6/blade 18/RU



MPO8-LC DM
6/blade 18/RU



LC Uniboot

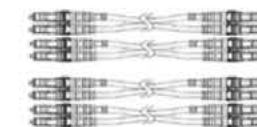

Supports DR4 applications over duplex base design

MPO8 to LC Uniboot

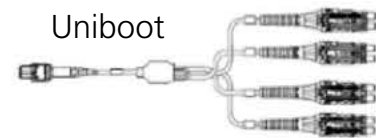

LC Uniboot to MPO8

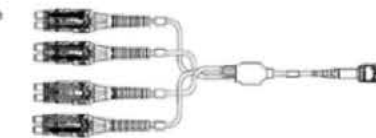

Supports QSFP-DD 4 pr applications over duplex base design

MPO8 to LC Uniboot

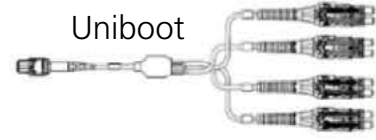

LC Uniboot

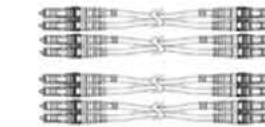

Note: Above scenarios can be mixed if application supports breakout lanes

MPO8 APC basic channels

Propel MPO8 ULL Singlemode Method B Enhanced Polarity – MPO Adapter BASE

MPO8-MPO8 APC trunk (pinned)

Supports QSFP 4 pr applications

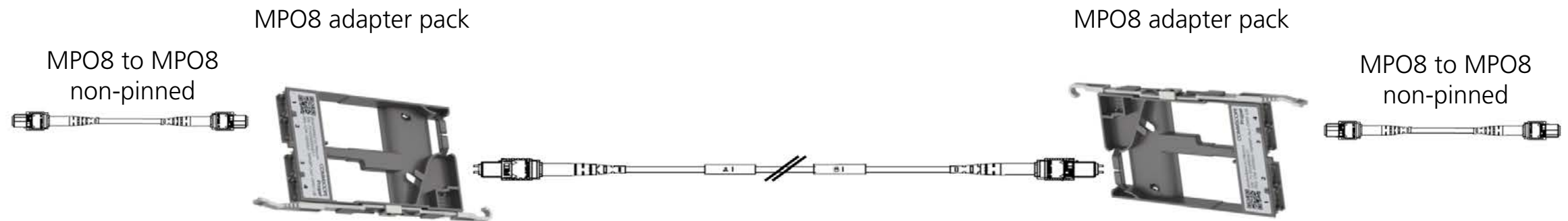

Supports 4 pr breakout applications

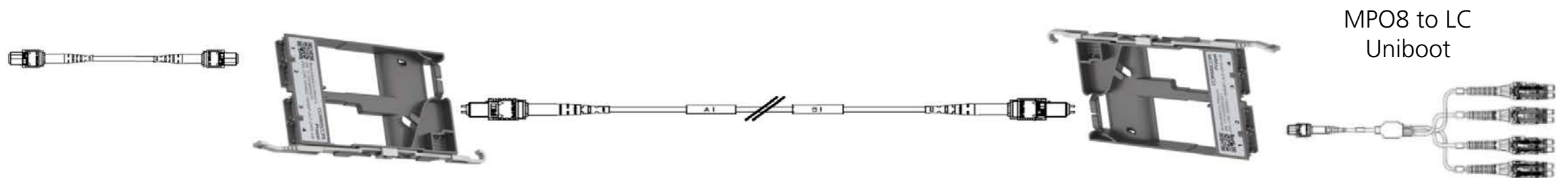

Supports 4 pr breakout applications

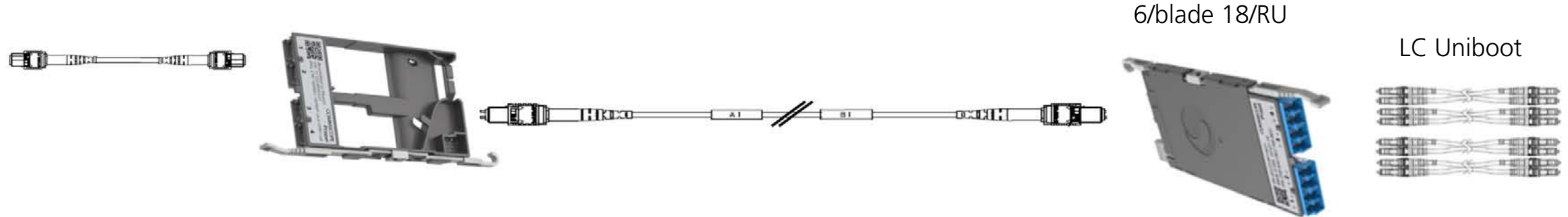

Note: Above scenarios can be mixed if application supports breakout lanes

MPO8 multimode APC basic channels

Propel MPO8 ULL Multimode APC OM4/OM5 Method B Enhanced Polarity

MPO8-MPO8 APC trunk (pinned)

Supports SR4-SR4 APC direct, breakout applications and similar PAM4 applications

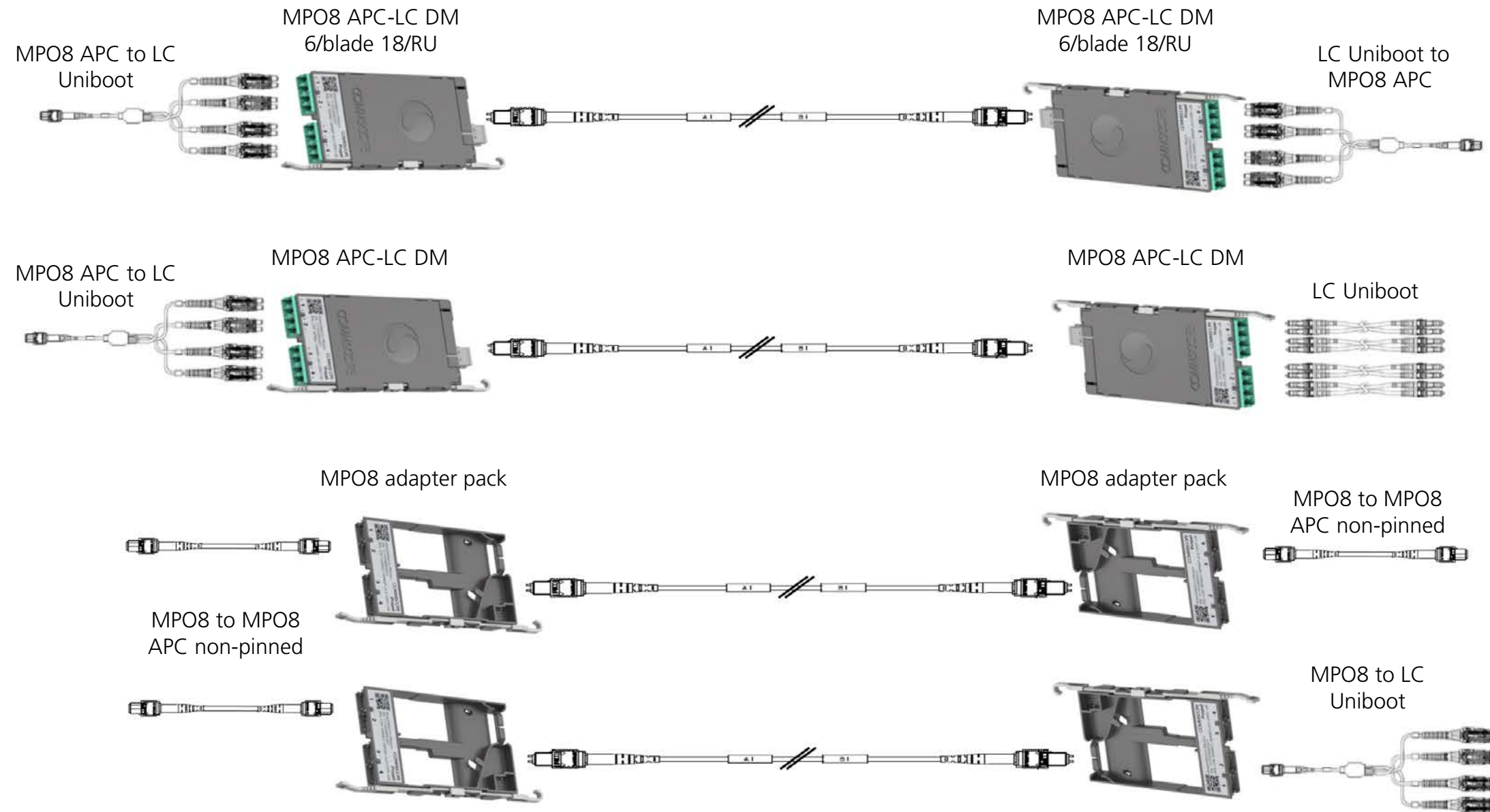

Note: Above scenarios can be mixed if application supports breakout lanes

MPO12 Solutions

MPO12 OM4/OM5 multimode UPC assemblies

MPO12 multimode UPC trunk cables

1 U	2 G	3 X	4 M	5 X	6 M	7 X	8 C	9 D	10 -	11 M	12 J	13 F	14-16 010
Construction type U Ultra-low loss	Cable family 3 Trunk, LSZH CPR B2ca G Trunk, Plenum J Trunk, Dual Rated (OFNR/LSZH)	Fiber type X OM4 multimode V OM5 WB multimode	Connector 1 MX 12f MPO (Pinned)	Connector 2 MX 12f MPO (Pinned)	Cordage size C 12f PmP Trunk, 2.0mm SU	Fiber count D 12-fiber F 24-fiber G 36-fiber H 48-fiber K 72-fiber L 96-fiber M 144-fiber N 192-fiber P 288-fiber	Color M OM4 Aqua N OM5 Lime green	Breakout length J 22" Break Propel No Pull Grip K 22" Break Propel Pull Grip	UOM F Feet M Meter	Length 010-999 ft 003-305 m			

MPO16 multimode APC array cords

1 U	2 Q	3 X	4 R	5 V	6 L	7 U	8 7	9 R	10 -	11 M	12 D	13 F	14-16 003
Construction type U Ultra-low loss	Cable family Q Plenum Array R Dual Rated (OFNR/LSZH)	Fiber type X OM4 multimode V OM5 WB multimode	Connector 1 RV 16f MPO MM APC (Non-Pinned)	Connector 2 LU LC Uniboot	Cordage size 7 16f PmP Array Cord, 3mm	Fiber count R 16-fiber	Color M OM4 Aqua N OM5 Lime green	Breakout length D 12" E 24" H 48" L 72"	UOM F Feet M Meter	Length 12 in 3-999 ft 24 in 4-999 ft 48 in 6-999 ft 72 in 8-999 ft 12 in 1-305 m 24-48 in 2-305 m 72 in 3-305 m			

400GBASE-SR8 to 400GBASE-SR8 (100m)
800GBASE-SR8 to 800GBASE-SR8 (100m)
800GBASE-VR8 to 800GBASE-VR8 (50m)

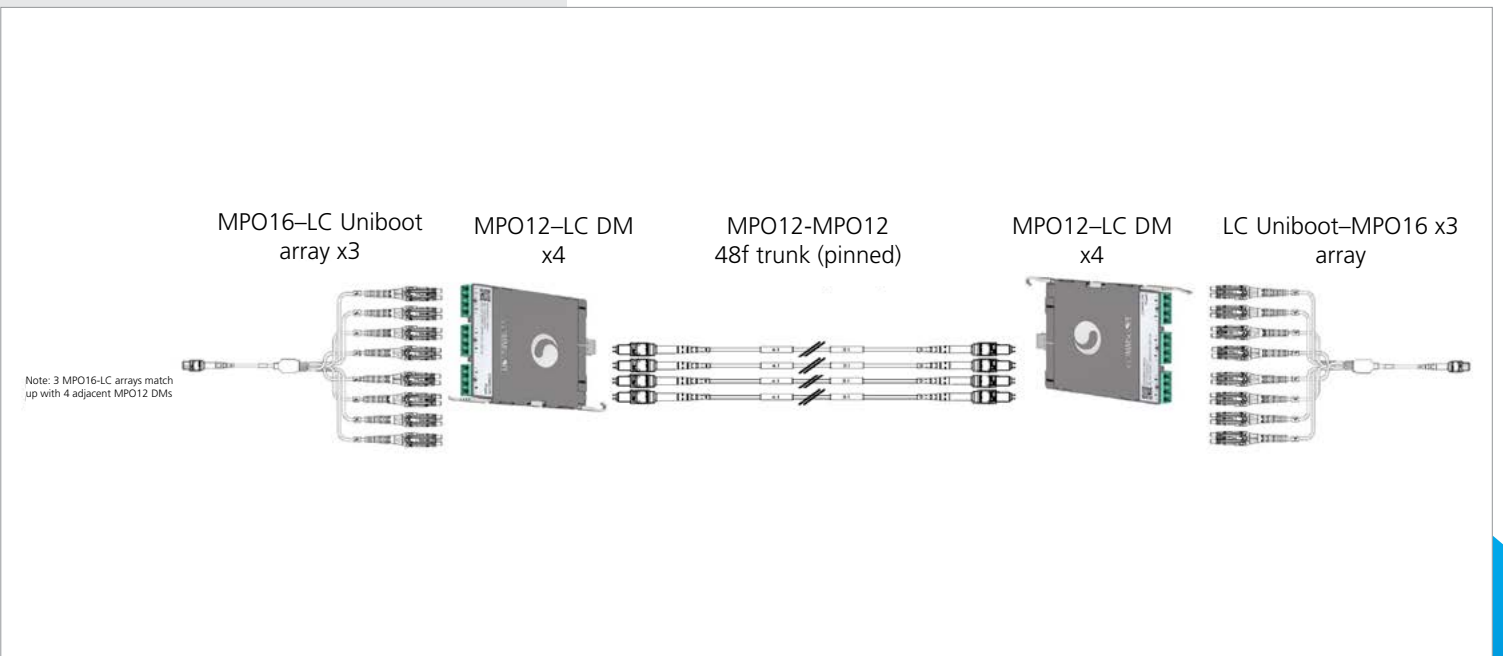

	Material ID	Product Number	Description	Fiber Type	Fiber Count	Front Interface	Rear Interface
MPO12 modules							
12 per 1RU	760252343	PPL-DM-12U-12LC-OM4-BEU	Propel ULL Distribution Module, Method B Enhanced	OM4	12	6 duplex LCs with internal shutters	1 MPO12 non-pinned with internal shutter
	760252344	PPL-DM-12U-12LC-OM5-BEU	Propel ULL Distribution Module, Method B Enhanced	OM5	12	6 duplex LCs with internal shutters	1 MPO12 non-pinned with internal shutter

For panel ordering information, refer to panel annex in the back of this guide.

MPO12 OM4/OM5 multimode UPC assemblies

MPO12 multimode UPC trunk cables

1	2	3	4	5	6	7	8	9	10	11	12	13	14-16
U	G	X	M	X	M	X	C	D	-	M	J	F	010
Construction type U Ultra-low loss	Cable family 3 Trunk, LSZH CPR B2ca G Trunk, Plenum J Trunk, Dual Rated (OFNR/LSZH)	Fiber type X OM4 multimode V OM5 WB multimode	Connector 1 MX 12f MPO (Pinned)	Connector 2 MX 12f MPO (Pinned)	Cordage size C 12f PmP Trunk, 2.0mm SU	Fiber count D 12-fiber F 24-fiber G 36-fiber H 48-fiber K 72-fiber L 96-fiber M 144-fiber N 192-fiber P 288-fiber	Color M OM4 Aqua N OM5 Lime green	Breakout length J 22" Break Propel No Pull Grip K 22" Break Propel Pull Grip	UOM F Feet M Meter	Length 010-999 ft 003-305 m			

MPO16 multimode APC array cords

1	2	3	4	5	6	7	8	9	10	11	12	13	14-16
U	Q	X	R	V	L	U	7	R	-	M	D	F	003
Construction type U Ultra-low loss	Cable family Q Plenum Array R Dual Rated (OFNR/LSZH)	Fiber type X OM4 multimode V OM5 WB multimode	Connector 1 RV 16f MPO MM APC (Non-Pinned)	Connector 2 LU LC Uniboot	Cordage size 7 16f PmP Array Cord, 3mm	Fiber count R 16-fiber	Color M OM4 Aqua N OM5 Lime green	Breakout length D 12" E 24" H 48" L 72"	UOM F Feet M Meter	Length 12 in 3-999 ft 24 in 4-999 ft 48 in 6-999 ft 72 in 8-999 ft 12 in 1-305 m 24-48 in 2-305 m 72 in 3-305 m			

SYSTIMAX Uniboot patch cords

1	2	3	4	5	6	7	8	9	10	11-12
U	D	X	L	U	L	2	-	X	F	010
Construction type U Ultra-low loss	Cable family D Plenum F LSZH/Riser	Fiber type X OM4 multimode V OM5 WB multimode	Connector 1 LU LC Uniboot	Connector 2 LU LC Uniboot	Cordage size K 1.5 mm 6 2.0 mm	Fiber count 2 2-fiber	Color M OM4 Aqua N OM5 Lime green	Breakout length X No breakout	UOM F Feet M Meter	Length 2-200 Feet 1-061 Meters

• Other lengths available please contact CommScope

	Material ID	Product Number	Description	Fiber Type	Fiber Count	Front Interface	Rear Interface
MPO12 modules							
12 per 1RU	760252343	PPL-DM-12U-12LC-OM4-BEU	Propel ULL Distribution Module, Method B Enhanced	OM4	12	6 duplex LCs with internal shutters	1 MPO12 non-pinned with internal shutter
	760252344	PPL-DM-12U-12LC-OM5-BEU	Propel ULL Distribution Module, Method B Enhanced	OM5	12	6 duplex LCs with internal shutters	1 MPO12 non-pinned with internal shutter

400GBASE-SR8 to 8x50GBASE-SR (100m)
800GBASE-VR8 to 8x100GBASE-VR1 (50m)
800GBASE-SR8 to 8x100GBASE-SR1 (100m)

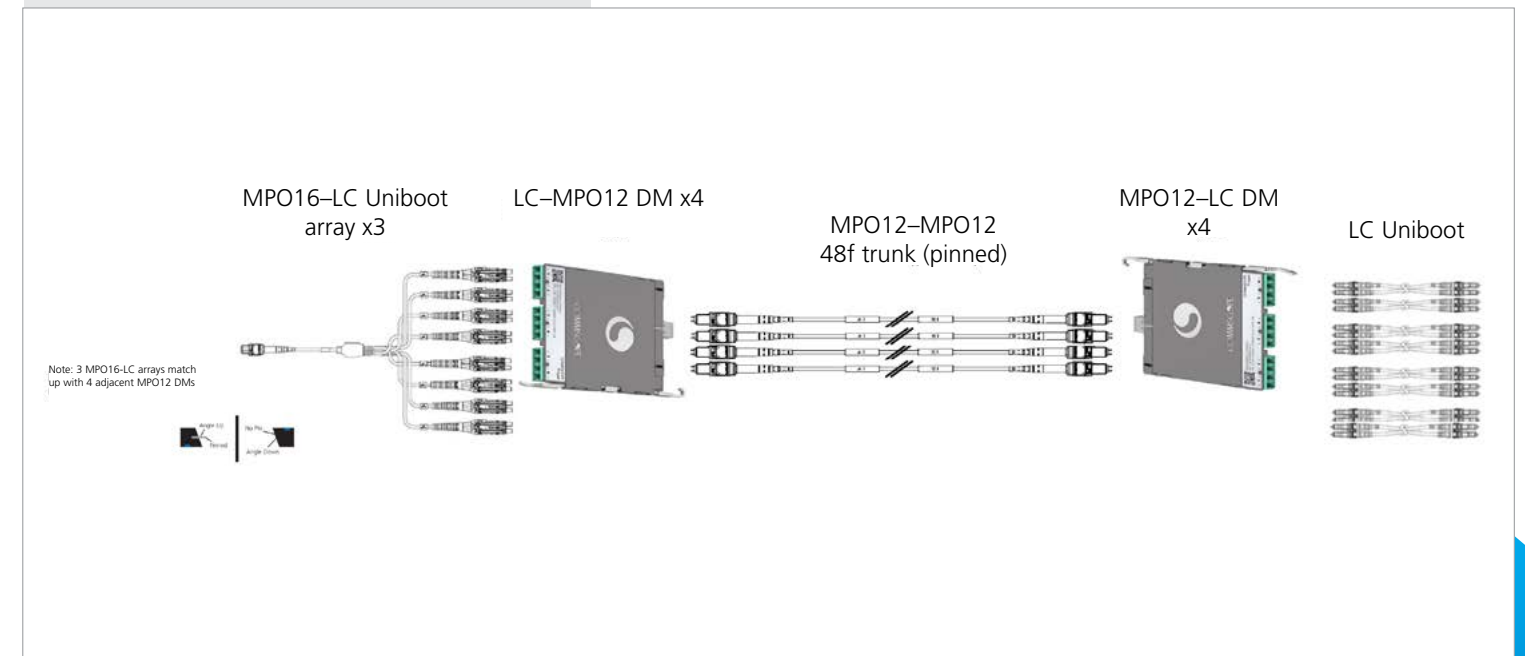

For panel ordering information, refer to panel annex in the back of this guide.

MPO12 OM4/OM5 multimode UPC assemblies

MPO12 multimode UPC trunk cables

1 U	2 G	3 X	4 M	5 X	6 M	7 X	8 C	9 D	10 -	11 M	12 J	13 F	14-16 010
Construction type U Ultra-low loss	Cable family 3 Trunk, LSZH CPR B2ca G Trunk, Plenum J Trunk, Dual Rated (OFNR/LSZH)	Fiber type X OM4 multimode V OM5 WB multimode	Connector 1 MX 12f MPO (Pinned)	Connector 2 MX 12f MPO (Pinned)	Cordage size C 12f PmP Trunk, 2.0mm SU	Fiber count D 12-fiber F 24-fiber G 36-fiber H 48-fiber K 72-fiber L 96-fiber M 144-fiber N 192-fiber P 288-fiber	Color M OM4 Aqua N OM5 Lime green	Breakout length J 22" Break Propel No Pull Grip K 22" Break Propel Pull Grip	UOM F Feet M Meter	Length 010-999 ft 003-305 m			

MPO12 multimode conversion UPC array cables

1 U	2 Q	3 X	4 Q	5 P	6 M	7 P	8 H	9 F	10 -	11 M	12 E	13 F	14-16 010
Construction type U Ultra-low loss	Cable family Q Plenum array R LSZH array	Fiber type X OM4 multimode V OM5 WB multimode	Connector 1 QP 8f MPO (Non-pinned)	Connector 2 MP 12f MPO (Non-pinned)	Cordage size H 24-fiber PmP Array Cord	Fiber count F 24-fiber	Color M OM4 Aqua N OM5 Lime green	Breakout length D 12 in breakout No gland E 24 in breakout No gland H 48 in breakout No gland L 72 in breakout No gland	UOM F Feet M Meter	Length 12" 3-999 ft 24" 4-999 ft 48" 6-999 ft 72" 8-999 ft 12" 1-305 m 12"-48" 2-305 m 72" 3-305 m			

SYSTIMAX Uniboot patch cords

1 U	2 D	3 X	4 L	5 U	6 6	7 2	8 -	9 X	10 F	11-12 010
Construction type U Ultra-low loss	Cable family D Plenum F LSZH/Riser	Fiber type X OM4 multimode V OM5 WB multimode	Connector 1 LU LC Uniboot	Connector 2 LU LC Uniboot	Cordage size K 1.5 mm 6 2.0 mm	Fiber count 2 2-fiber	Color M OM4 Aqua N OM5 Lime green	Breakout length X No breakout	UOM F Feet M Meter	Length 2-200 Feet 1-061 Meters

• Other lengths available please contact CommScope

	Material ID	Product Number	Description	Fiber Type	Fiber Count	Front Interface	Rear Interface
MPO12 modules							
12 per 1RU	760252343	PPL-DM-12U-12LC-OM4-BEU	Propel ULL Distribution Module, Method B Enhanced	OM4	12	6 duplex LCs with internal shutters	1 MPO12 non-pinned with internal shutter
	760252344	PPL-DM-12U-12LC-OM5-BEU	Propel ULL Distribution Module, Method B Enhanced	OM5	12	6 duplex LCs with internal shutters	1 MPO12 non-pinned with internal shutter
12-fiber adapter packs							
12 per 1RU	760252372	PPL-AP-6-MPO-ALL-B	Propel pass-through adapter pack, Type B	All	72	6 MPO12 Key Up with internal shutters	6 MPO12 Key Up with dust caps

40GBASE-SR4 to 4x10GBASE-SR (150m)
100GBASE-SR4 to 4x25GBASE-SR (100m)

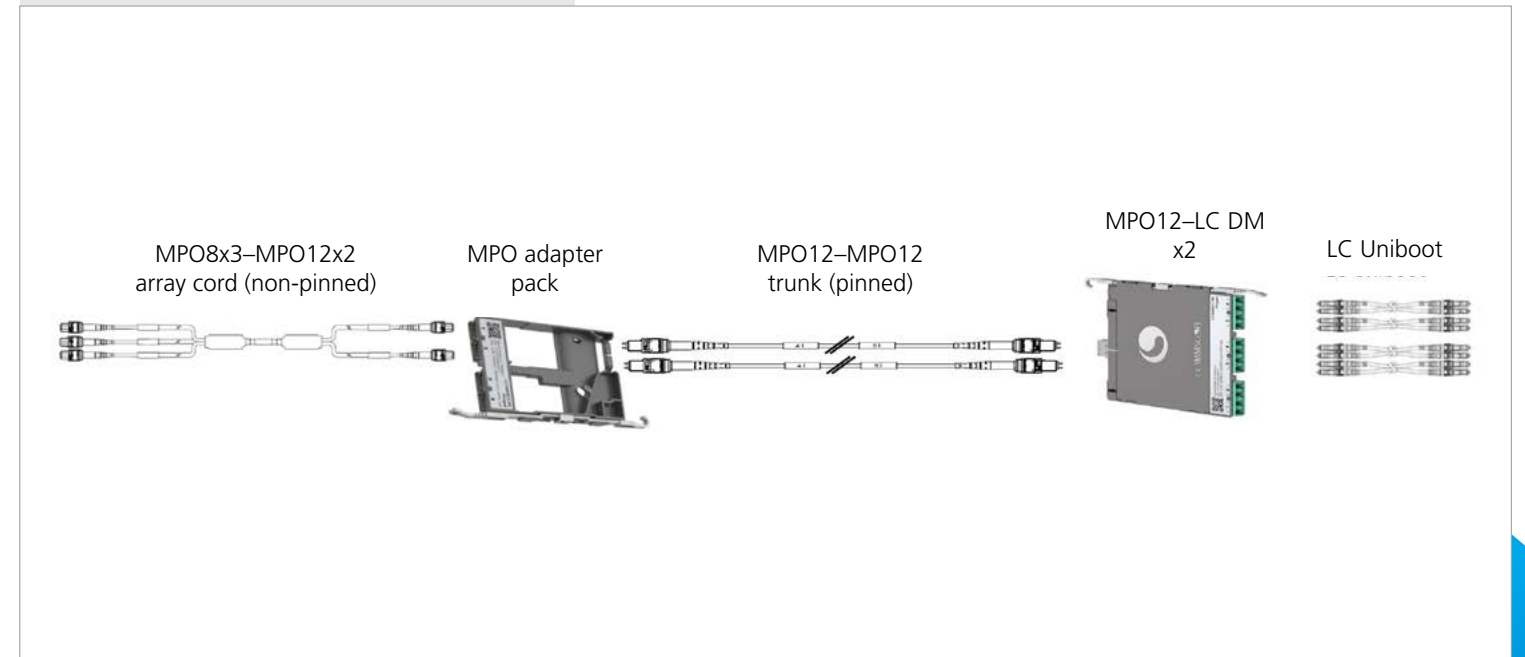

For panel ordering information, refer to panel annex in the back of this guide.

MPO12 OM4/OM5 multimode UPC assemblies

MPO12 multimode UPC trunk cables

1 U	2 G	3 X	4 M	5 X	6 M	7 X	8 C	9 D	10 -	11 M	12 J	13 F	14-16 010
Construction type U Ultra-low loss	Cable family 3 Trunk, LSZH CPR B2ca G Trunk, Plenum J Trunk, Dual Rated (OFNR/LSZH)	Fiber type X OM4 multimode V OM5 WB multimode	Connector 1 MX 12f MPO (Pinned)	Connector 2 MX 12f MPO (Pinned)	Cordage size C 12f PmP Trunk, 2.0mm SU	Fiber count D 12-fiber F 24-fiber G 36-fiber H 48-fiber K 72-fiber L 96-fiber M 144-fiber N 192-fiber P 288-fiber	Color M OM4 Aqua N OM5 Lime green	Breakout length J 22" Break Propel No Pull Grip K 22" Break Propel Pull Grip	UOM F Feet M Meter	Length 010-999 ft 003-305 m			

MPO8 multimode UPC array cords

1 U	2 Q	3 X	4 Q	5 P	6 L	7 U	8 F	9 8	10 -	11 M	12 D	13 F	14-16 010
Construction type U Ultra-low loss	Cable family Q Plenum Array R Dual Rated (OFNR/LSZH)	Fiber type X OM4 multimode V OM5 WB multimode	Connector 1 QP 8f MPO MM APC (Non-pinned)	Connector 2 LU LC Uniboot	Cordage size F 8f PmP Array Cord, 2 mm	Fiber count 8 8-fiber	Color M OM4 Aqua N OM5 Lime green	Breakout length D 12" E 24" H 48" L 72"	UOM F Feet M Meter	Length 12 in 3-999 ft 24 in 4-999 ft 48 in 6-999 ft 72 in 8-999 ft 12 in 1-305 m 24-48 in 2-305 m 72 in 3-305 m			

SYSTIMAX Uniboot patch cords

1 U	2 D	3 X	4 L	5 L	6 6	7 2	8 -	9 X	10 F	11-12 010
Construction type U Ultra-low loss	Cable family D Plenum F LSZH/Riser	Fiber type X OM4 multimode V OM5 WB multimode	Connector 1 LU LC Uniboot	Connector 2 LU LC Uniboot	Cordage size K 1.5 mm 6 2.0 mm	Fiber count 2 2-fiber	Color M OM4 Aqua N OM5 Lime green	Breakout length X No breakout	UOM F Feet M Meter	Length 2-200 Feet 1-061 Meters

• Other lengths available please contact CommScope

	Material ID	Product Number	Description	Fiber Type	Fiber Count	Front Interface	Rear Interface
MPO12 modules							
12 per 1RU	760252343	PPL-DM-12U-12LC-OM4-BEU	Propel ULL Distribution Module, Method B Enhanced	OM4	12	6 duplex LCs with internal shutters	1 MPO12 non-pinned with internal shutter
	760252344	PPL-DM-12U-12LC-OM5-BEU	Propel ULL Distribution Module, Method B Enhanced	OM5	12	6 duplex LCs with internal shutters	1 MPO12 non-pinned with internal shutter

40GBASE-SR4 to 4x10GBASE-SR (150m)
100GBASE-SR4 to 4x25GBASE-SR (100m)

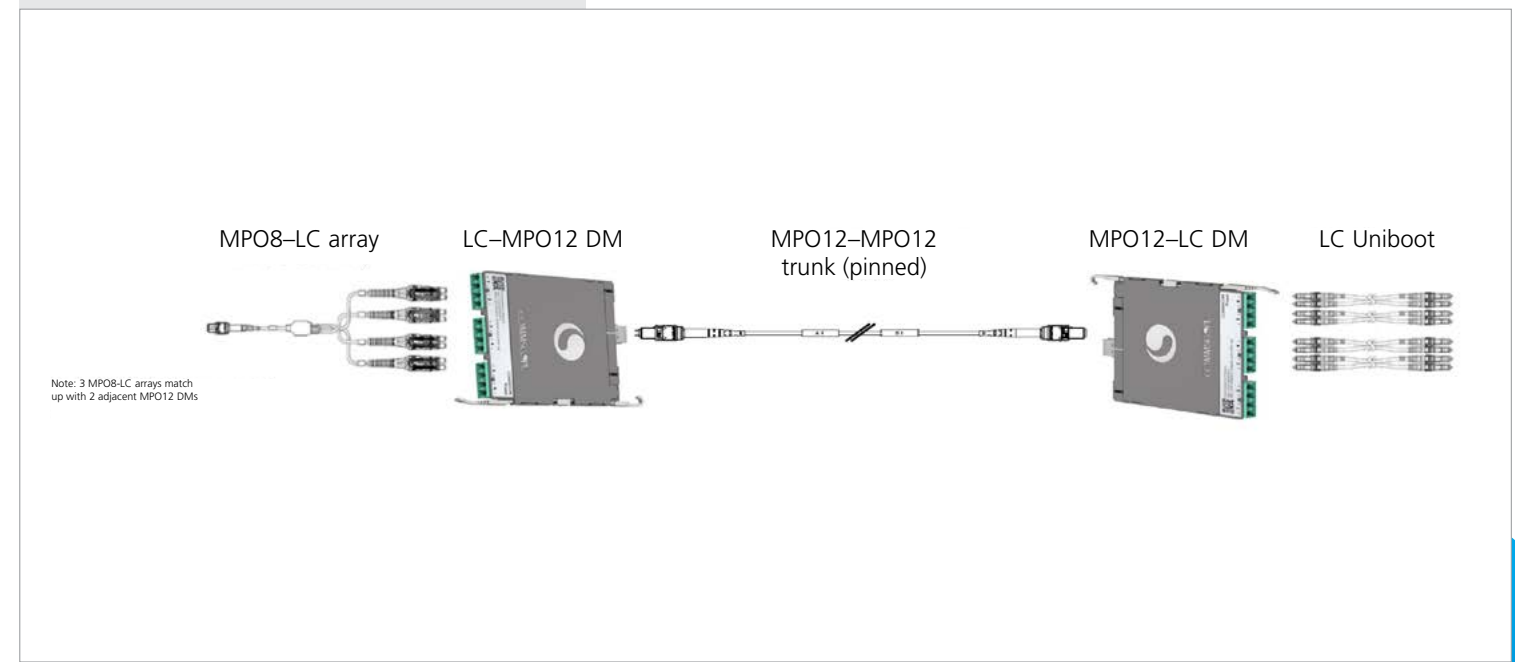

For panel ordering information, refer to panel annex in the back of this guide.

MPO12 OM4/OM5 multimode UPC assemblies

MPO12 multimode UPC trunk cables

1 U	2 G	3 X	4 M	5 X	6 M	7 X	8 C	9 D	10 -	11 M	12 J	13 F	14-16 010
Construction type U Ultra-low loss	Cable family 3 Trunk, LSZH CPR B2ca G Trunk, Plenum J Trunk, Dual Rated (OFNR/LSZH)	Fiber type X OM4 multimode V OM5 WB multimode	Connector 1 MX 12f MPO (Pinned)	Connector 2 MX 12f MPO (Pinned)	Cordage size C 12f PmP Trunk, 2.0mm SU	Fiber count D 12-fiber F 24-fiber G 36-fiber H 48-fiber K 72-fiber L 96-fiber M 144-fiber N 192-fiber P 288-fiber	Color M OM4 Aqua N OM5 Lime green	Breakout length J 22" Break Propel No Pull Grip K 22" Break Propel Pull Grip	UOM F Feet M Meter	Length 010-999 ft 003-305 m			

MPO12 multimode conversion UPC array cables

1 U	2 Q	3 X	4 Q	5 P	6 M	7 P	8 H	9 F	10 -	11 M	12 E	13 F	14-16 010
Construction type U Ultra-low loss	Cable family Q Plenum array R LSZH array	Fiber type X OM4 multimode V OM5 WB multimode	Connector 1 QP 8f MPO MM UPC (Non-pinned)	Connector 2 MP 12f MPO (Non-pinned)	Cordage size H 24-fiber PmP Array Cord	Fiber count F 24-fiber	Color M OM4 Aqua N OM5 Lime green	Breakout length D 12 in breakout No gland E 24 in breakout No gland H 48 in breakout No gland L 72 in breakout No gland	UOM F Feet M Meter	Length 12" 3-999 ft 24" 4-999 ft 48" 6-999 ft 72" 8-999 ft 12" 1-305 m 12"-48" 2-305 m 72" 3-305 m			

40GBASE-SR4 to 40GBASE-SR4 (150m)
 100GBASE-SR4 to 100GBASE-SR4 (100m)
 400GBASE-SR4.2 to 400GBASE-SR4.2 (BiDi) (100m/OM4, 150m/OM5)
 800GBASE-SR4.2 to 800GBASE-SR4.2 (BiDi) (MSA) (100m/OM4, 150m/OM5)

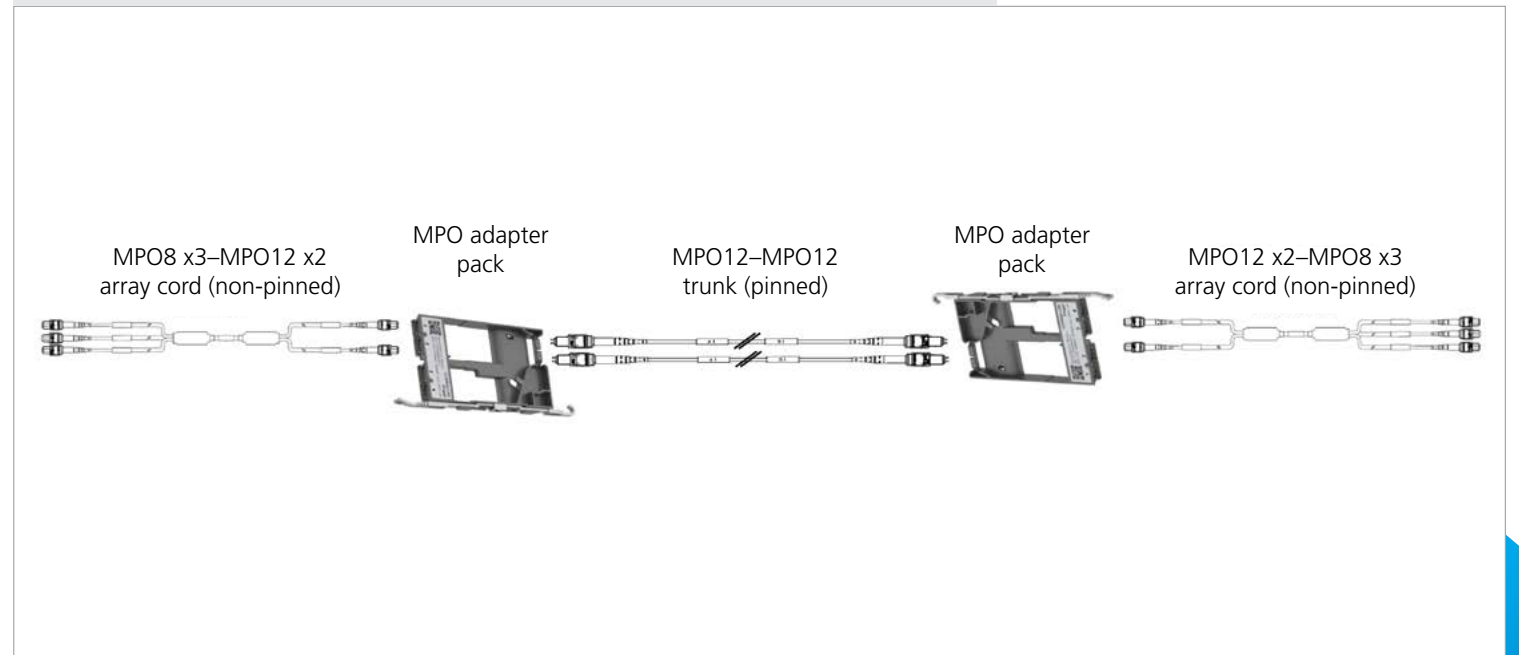

	Material ID	Product Number	Description	Fiber Type	Fiber Count	Front Interface	Rear Interface
12-fiber adapter packs							
12 per 1RU	760252372	PPL-AP-6-MPO-ALL-B	Propel pass-through adapter pack, Type B	All	72	6 MPO12 Key Up with internal shutters	6 MPO12 Key Up with dust caps

For panel ordering information, refer to panel annex in the back of this guide.

MPO12 OM4/OM5 multimode UPC assemblies

MPO12 multimode UPC trunk cables

1	2	3	4	5	6	7	8	9	10	11	12	13	14-16
U	G	X	M	X	M	X	C	D	-	M	J	F	010
Construction type U Ultra-low loss	Cable family 3 Trunk, LSZH CPR B2ca G Trunk, Plenum J Trunk, Dual Rated (OFNR/LSZH)	Fiber type X OM4 multimode V OM5 WB multimode	Connector 1 MX 12f MPO (Pinned)	Connector 2 MX 12f MPO (Pinned)	Cordage size C 12f PmP Trunk, 2.0mm SU	Fiber count D 12-fiber F 24-fiber G 36-fiber H 48-fiber K 72-fiber L 96-fiber M 144-fiber N 192-fiber P 288-fiber	Color M OM4 Aqua N OM5 Lime green	Breakout length J 22" Break Propel No Pull Grip K 22" Break Propel Pull Grip	UOM F Feet M Meter	Length 010-999 ft 003-305 m			

MPO12 multimode UPC array cords

1	2	3	4	5	6	7	8	9	10	11	12	13	14-16
U	Q	X	Q	P	L	U	F	8	-	M	D	F	010
Construction type U Ultra-low loss	Cable family Q Plenum Array R Dual Rated (OFNR/LSZH)	Fiber type X OM4 multimode V OM5 WB multimode	Connector 1 QP 8f MPO MM UPC (Non-pinned)	Connector 2 LU LC Uniboot	Cordage size F 8f PmP Array Cord, 2 mm	Fiber count 8 8-fiber	Color M OM4 Aqua N OM5 Lime green	Breakout length D 12" E 24" H 48" L 72"	UOM F Feet M Meter	Length 12 in 3-999 ft 24 in 4-999 ft 48 in 6-999 ft 72 in 8-999 ft 12 in 1-305 m 24-48 in 2-305 m 72 in 3-305 m			

SYSTIMAX Uniboot patch cords

1	2	3	4	5	6	7	8	9	10	11-12
U	D	X	L	U	6	2	-	X	F	010
Construction type U Ultra-low loss	Cable family D Plenum F LSZH/Riser	Fiber type X OM4 multimode V OM5 WB multimode	Connector 1 LU LC Uniboot	Connector 2 LU LC Uniboot	Cordage size K 1.5 mm 6 2.0 mm	Fiber count 2 2-fiber	Color M OM4 Aqua N OM5 Lime green	Breakout length X No breakout	UOM F Feet M Meter	Length 2-200 Feet 1-061 Meters

• Other lengths available please contact CommScope

	Material ID	Product Number	Description	Fiber Type	Fiber Count	Front Interface	Rear Interface
MPO12 modules							
12 per 1RU	760252343	PPL-DM-12U-12LC-OM4-BEU	Propel ULL Distribution Module, Method B Enhanced	OM4	12	6 duplex LCs with internal shutters	1 MPO12 non-pinned with internal shutter
	760252344	PPL-DM-12U-12LC-OM5-BEU	Propel ULL Distribution Module, Method B Enhanced	OM5	12	6 duplex LCs with internal shutters	1 MPO12 non-pinned with internal shutter

40GBASE-SR4 to 4x10GBASE-SR (150m)
100GBASE-SR4 to 4x25GBASE-SR (100m)

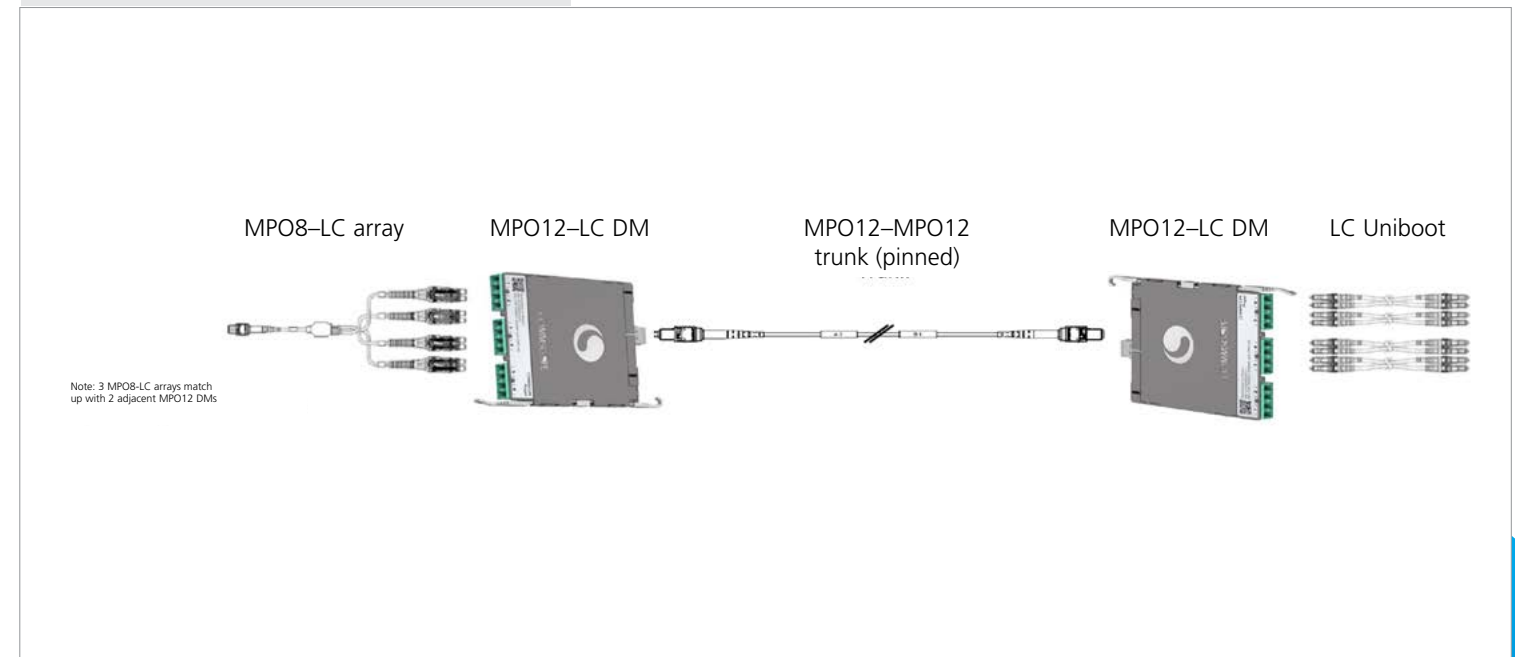

For panel ordering information, refer to panel annex in the back of this guide.

MPO12 singlemode APC assemblies

MPO12 singlemode APC trunk cables

1	2	3	4	5	6	7	8	9	10	11	12	13	14-16
U	G	G	M	X	M	X	C	D	-	J	J	F	010
Construction type U Ultra-low loss	Cable family 3 Trunk, LSZH CPR B2ca G Trunk, Plenum J Trunk, Dual Rated (OFNR/LSZH)	Fiber type G Singlemode (A2)	Connector 1 MX 12f MPO (Pinned)	Connector 2 MX 12f MPO (Pinned)	Cordage size C 12f PmP Trunk, 2.0mm SU	Fiber count D 12-fiber F 24-fiber G 36-fiber H 48-fiber K 72-fiber L 96-fiber M 144-fiber N 192-fiber P 288-fiber	Color J Yellow	Breakout length J 22" Break Propel No Pull Grip K 22" Break Propel Pull Grip	UOM F Feet M Meter	Length 010-999 ft 003-305 m			

MPO12 singlemode conversion APC array cables

1	2	3	4	5	6	7	8	9	10	11	12	13	14-16
U	Q	G	Q	P	M	P	H	F	-	J	D	F	010
Construction type U Ultra-low loss	Cable family Q Plenum array R LSZH array	Fiber type G Singlemode (A2)	Connector 1 QP 8f MPO (Non-pinned)	Connector 2 MP 12f MPO (Non-pinned)	Cordage size H 24-fiber PmP Array Cord	Fiber count F 24-fiber	Color J Yellow	Breakout length D 12 in breakout No gland E 24 in breakout No gland H 48 in breakout No gland L 72 in breakout No gland	UOM F Feet M Meter	Length 12" 3-999 ft 24" 4-999 ft 48" 6-999 ft 72" 8-999 ft 12" 1-305 m 12"-48" 2-305 m 72" 3-305 m			

400GBASE-DR4 to 400GBASE-DR4 (500m)

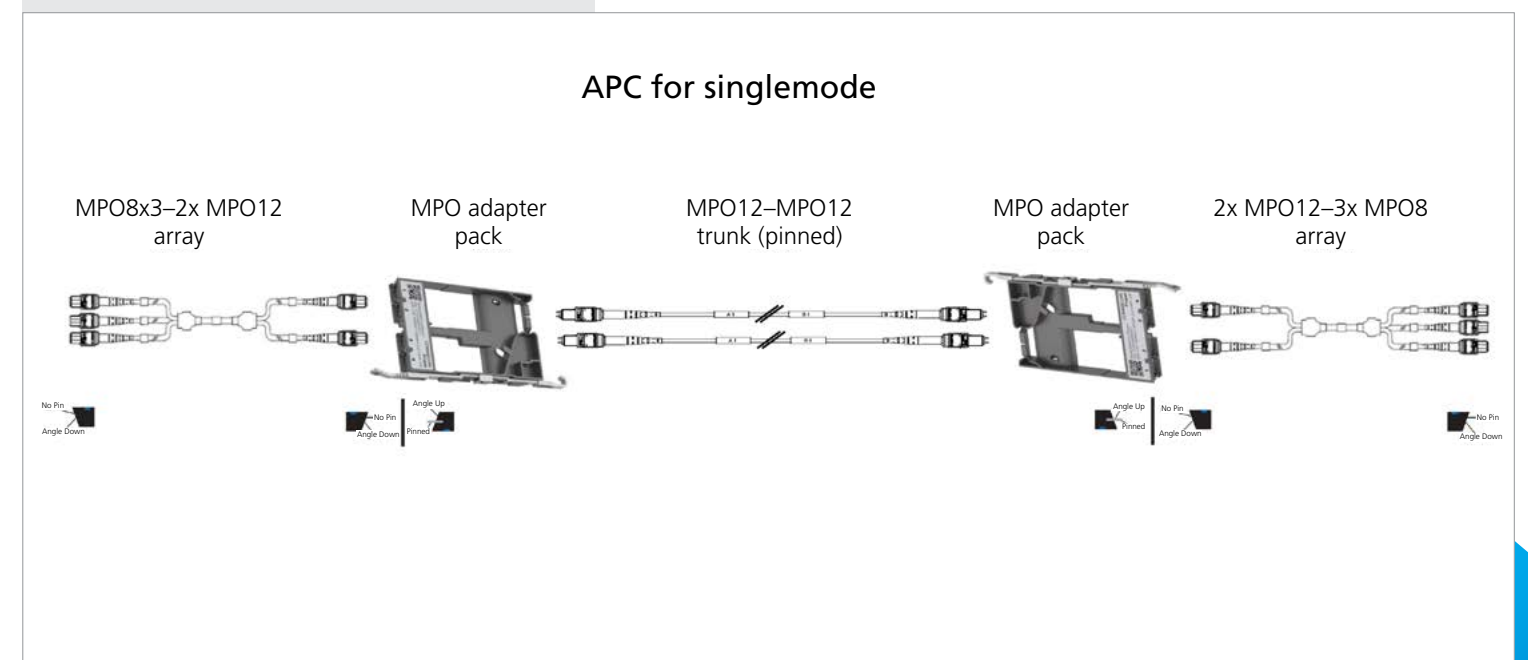

	Material ID	Product Number	Description	Fiber Type	Fiber Count	Front Interface	Rear Interface
12-fiber adapter packs							
12 per 1RU	760252372	PPL-AP-6-MPO-ALL-B	Propel pass-through adapter pack, Type B	All	72	6 MPO12 Key Up with internal shutters	6 MPO12 Key Up with dust caps

For panel ordering information, refer to panel annex in the back of this guide.

MPO12 singlemode APC assemblies

MPO12 singlemode APC trunk cables

1 U	2 G	3 G	4 M	5 X	6 M	7 X	8 C	9 D	10 -	11 J	12 J	13 F	14-16 010
Construction type U Ultra-low loss	Cable family 3 Trunk, LSZH CPR B2ca G Trunk, Plenum J Trunk, Dual Rated (OFNR/LSZH)	Fiber type G Singlemode (A2)	Connector 1 MX 12f MPO (Pinned)	Connector 2 MX 12f MPO (Pinned)	Cordage size C 12f PmP Trunk, 2.0mm SU	Fiber count D 12-fiber F 24-fiber G 36-fiber H 48-fiber K 72-fiber L 96-fiber M 144-fiber N 192-fiber P 288-fiber	Color J Yellow	Breakout length J 22" Break Propel No Pull Grip K 22" Break Propel Pull Grip	UOM F Feet M Meter	Length 010-999 ft 003-305 m			

MPO12 singlemode conversion APC array cables

1 U	2 Q	3 G	4 Q	5 P	6 M	7 P	8 H	9 F	10 -	11 J	12 D	13 F	14-16 010
Construction type U Ultra-low loss	Cable family Q Plenum array R LSZH array	Fiber type G Singlemode (A2)	Connector 1 QP 8f MPO (Non-pinned)	Connector 2 MP 12f MPO (Non-pinned)	Cordage size H 24-fiber PmP Array Cord	Fiber count F 24-fiber	Color J Yellow	Breakout length D 12 in breakout No gland E 24 in breakout No gland H 48 in breakout No gland L 72 in breakout No gland	UOM F Feet M Meter	Length 12" 3-999 ft 24" 4-999 ft 48" 6-999 ft 72" 8-999 ft 12" 1-305 m 12"-48" 2-305 m 72" 3-305 m			

SYSTIMAX Uniboot patch cords

1 U	2 D	3 G	4 L	5 U	6 6	7 -	8 J	9 X	10 F	11-12 010
Construction type U Ultra-low loss	Cable family D Plenum F LSZH/Riser	Fiber type G Singlemode (A2)	Connector 1 LU LC Uniboot	Connector 2 LU LC Uniboot	Cordage size K 1.5 mm 6 2.0 mm	Fiber count 2 2-fiber	Color J Yellow	Breakout length X No breakout	UOM F Feet M Meter	Length 2-200 Feet 1-061 Meters

• Other lengths available please contact CommScope

	Material ID	Product Number	Description	Fiber Type	Fiber Count	Front Interface	Rear Interface
MPO12 modules							
12 per 1RU	760252345	PPL-DM-12AU-12LC-SM-BEU	Propel ULL Distribution Module, Method B Enhanced	OS2	12	6 duplex LCs with internal shutters	1 MPO12/APC non-pinned with internal shutter
12-fiber adapter packs							
12 per 1RU	760252372	PPL-AP-6-MPO-ALL-B	Propel pass-through adapter pack, Type B	All	72	6 MPO12 Key Up with internal shutters	6 MPO12 Key Up with dust caps

400GBASE-DR4 to 4x100GBASE-DR (500m)

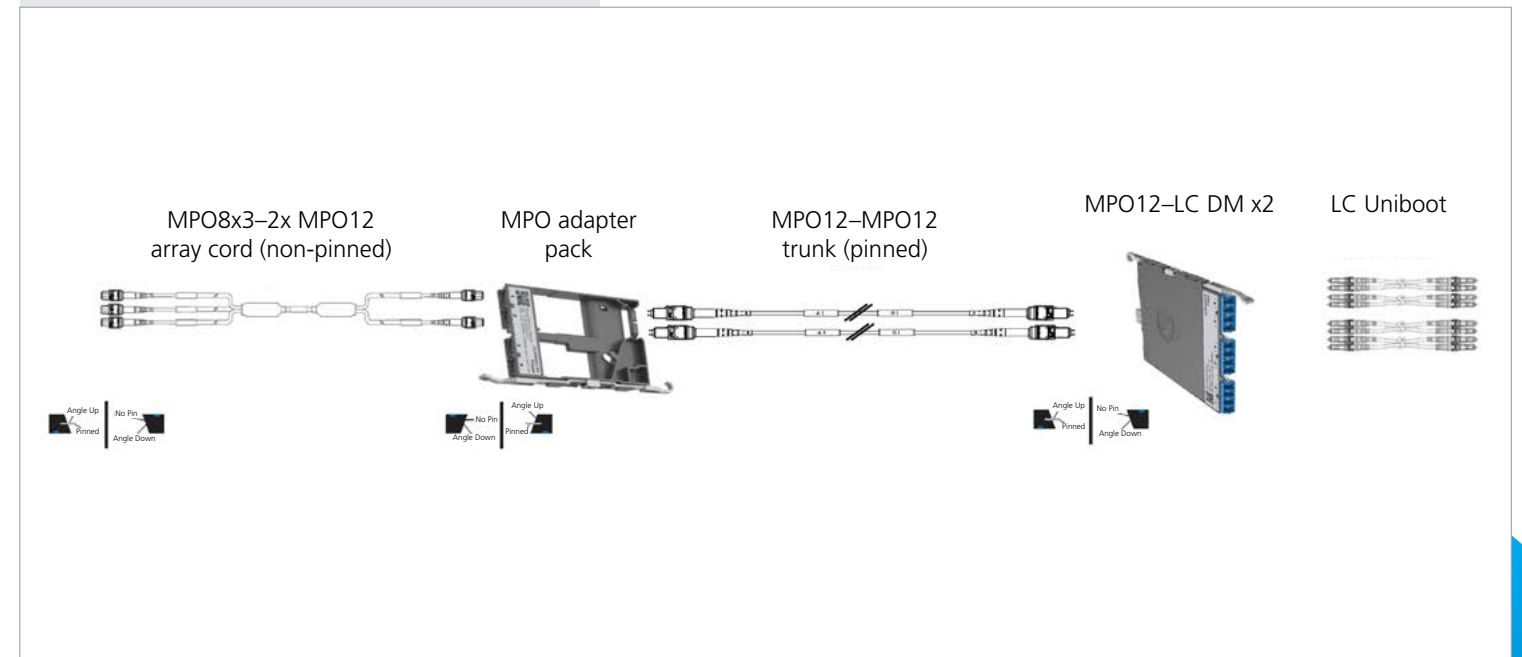

For panel ordering information, refer to panel annex in the back of this guide.

MPO12 singlemode APC assemblies

MPO12 singlemode APC trunk cables

1 U	2 G	3 G	4 M	5 X	6 M	7 X	8 C	9 D	10 -	11 J	12 J	13 F	14-16 010
Construction type U Ultra-low loss	Cable family 3 Trunk, LSZH CPR B2ca G Trunk, Plenum J Trunk, Dual Rated (OFNR/LSZH)	Fiber type G Singlemode (A2)	Connector 1 MX 12f MPO (Pinned)	Connector 2 MX 12f MPO (Pinned)	Cordage size C 12f PmP Trunk, 2.0mm SU	Fiber count D 12-fiber F 24-fiber G 36-fiber H 48-fiber K 72-fiber L 96-fiber M 144-fiber N 192-fiber P 288-fiber	Color J Yellow	Breakout length J 22" Break Propel No Pull Grip K 22" Break Propel Pull Grip	UOM F Feet M Meter	Length 010-999 ft 003-305 m			

MPO12 conversion APC array cables

1 U	2 Q	3 G	4 R	5 P	6 M	7 P	8 A	9 H	10 -	11 J	12 D	13 F	14-16 010
Construction type U Ultra-low loss	Cable family Q Plenum Array R Dual Rated (OFNR/LSZH)	Fiber type G Singlemode (A2)	Connector 1 RP 16f MPO SM APC (Non-pinned)	Connector 2 MP 12f MPO (Non-pinned)	Cordage size A 12f PmP Array cord, 3mm	Fiber count H 48-fiber	Color J Yellow	Breakout length D 12" E 24" H 48" L 72"	UOM F Feet M Meter	Length 24" 4-999 ft 48" 6-999 ft 72" 8-999 ft 12" 1-305 m 12"-48" 2-305 m 72" 3-305 m			

800GBASE-DR8+ to 800GBASE-DR8+ (2 km)

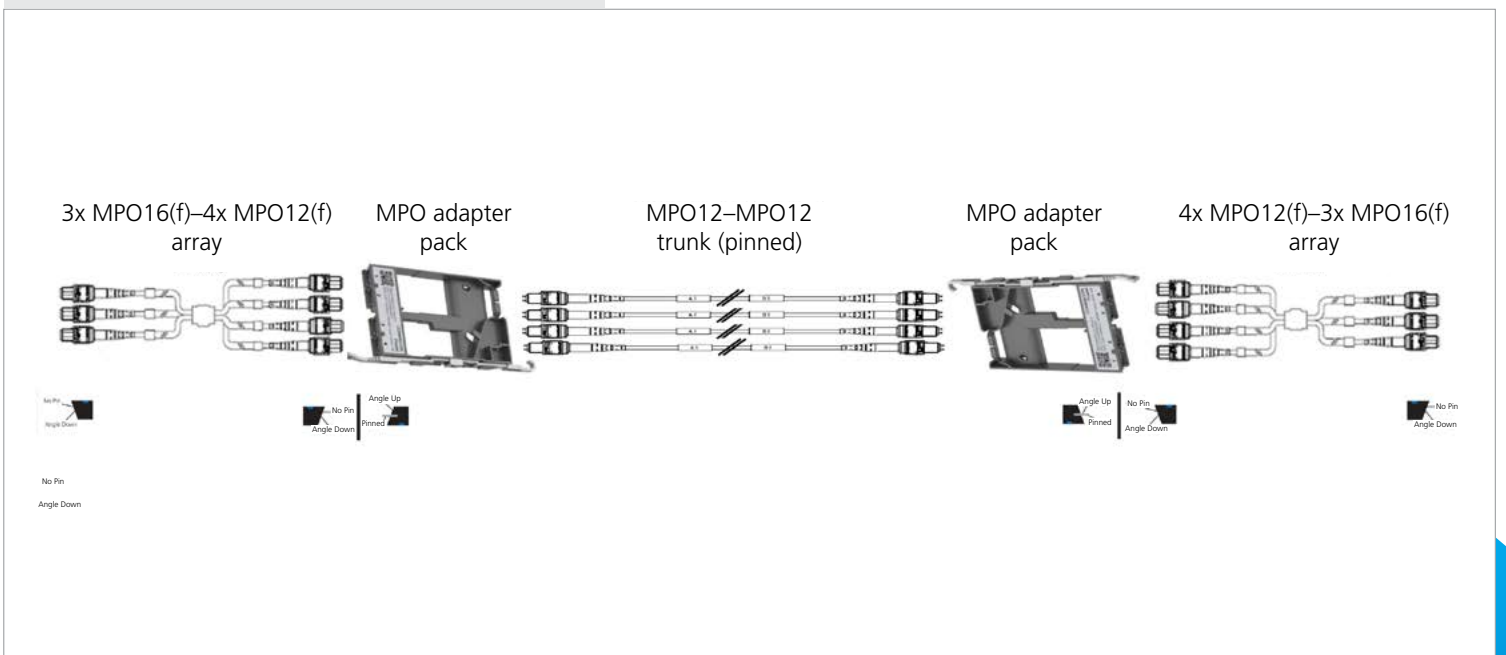

	Material ID	Product Number	Description	Fiber Type	Fiber Count	Front Interface	Rear Interface
12-fiber adapter packs							
12 per 1RU	760252372	PPL-AP-6-MPO-ALL-B	Propel pass-through adapter pack, Type B	All	72	6 MPO 8/12/24 Key Up with internal shutters	6 MPO 8/12/24 Key Up with dust caps

For panel ordering information, refer to panel annex in the back of this guide.

MPO12 singlemode APC assemblies

MPO12 singlemode APC trunk cables

1 U	2 G	3 G	4 M	5 X	6 M	7 X	8 C	9 D	10 -	11 M	12 J	13 F	14-16 010
Construction type U Ultra-low loss	Cable family 3 Trunk, LSZH CPR B2ca G Trunk, Plenum J Trunk, Dual Rated (OFNR/LSZH)	Fiber type G Singlemode (A2)	Connector 1 MX 12f MPO (Pinned)	Connector 2 MX 12f MPO (Pinned)	Cordage size C 12f PmP Trunk, 2.0mm SU	Fiber count D 12-fiber F 24-fiber G 36-fiber H 48-fiber K 72-fiber L 96-fiber M 144-fiber N 192-fiber P 288-fiber	Color J Yellow	Breakout length J 22" Break Propel No Pull Grip K 22" Break Propel Pull Grip	UOM F Feet M Meter	Length 010-999 ft 003-305 m			

MPO16 singlemode APC array cords

1 U	2 Q	3 G	4 R	5 P	6 L	7 U	8 7	9 R	10 -	11 J	12 D	13 F	14-16 003
Construction type U Ultra-low loss	Cable family Q Plenum Array R Dual Rated (OFNR/LSZH)	Fiber type G Singlemode (A2)	Connector 1 RP 16f MPO SM APC (Non-Pinned)	Connector 2 LU LC Uniboot	Cordage size 7 16f PmP Array Cord, 3mm	Fiber count R 16-fiber	Color J Yellow	Breakout length D 12" E 24" H 48" L 72"	UOM F Feet M Meter	Length 12 in 3-999 ft 24 in 4-999 ft 48 in 6-999 ft 72 in 8-999 ft 12 in 1-305 m 24-48 in 2-305 m 72 in 3-305 m			

SYSTIMAX Uniboot patch cords

1 U	2 D	3 G	4 L	5 U	6 6	7 2	8 -	9 J	10 X	11-12 010
Construction type U Ultra-low loss	Cable family D Plenum F LSZH/Riser	Fiber type G Singlemode (A2)	Connector 1 LU LC Uniboot	Connector 2 LU LC Uniboot	Cordage size K 1.5 mm 6 2.0 mm	Fiber count 2 2-fiber	Color J Yellow	Breakout length X No breakout	UOM F Feet M Meter	Length 2-200 Feet 1-061 Meters

• Other lengths available please contact CommScope

	Material ID	Product Number	Description	Fiber Type	Fiber Count	Front Interface	Rear Interface
MPO12 modules							
12 per 1RU	760252345	PPL-DM-12AU-12LC-SM-BEU	Propel ULL Distribution Module, Method B Enhanced	OS2	12	6 duplex LCs with internal shutters	1 MPO12/APC non-pinned with internal shutter

400GBASE-DR8 to 8x50GBASE-DR (500m)
800GBASE-DR8 to 8x100GBASE-DR (500m)

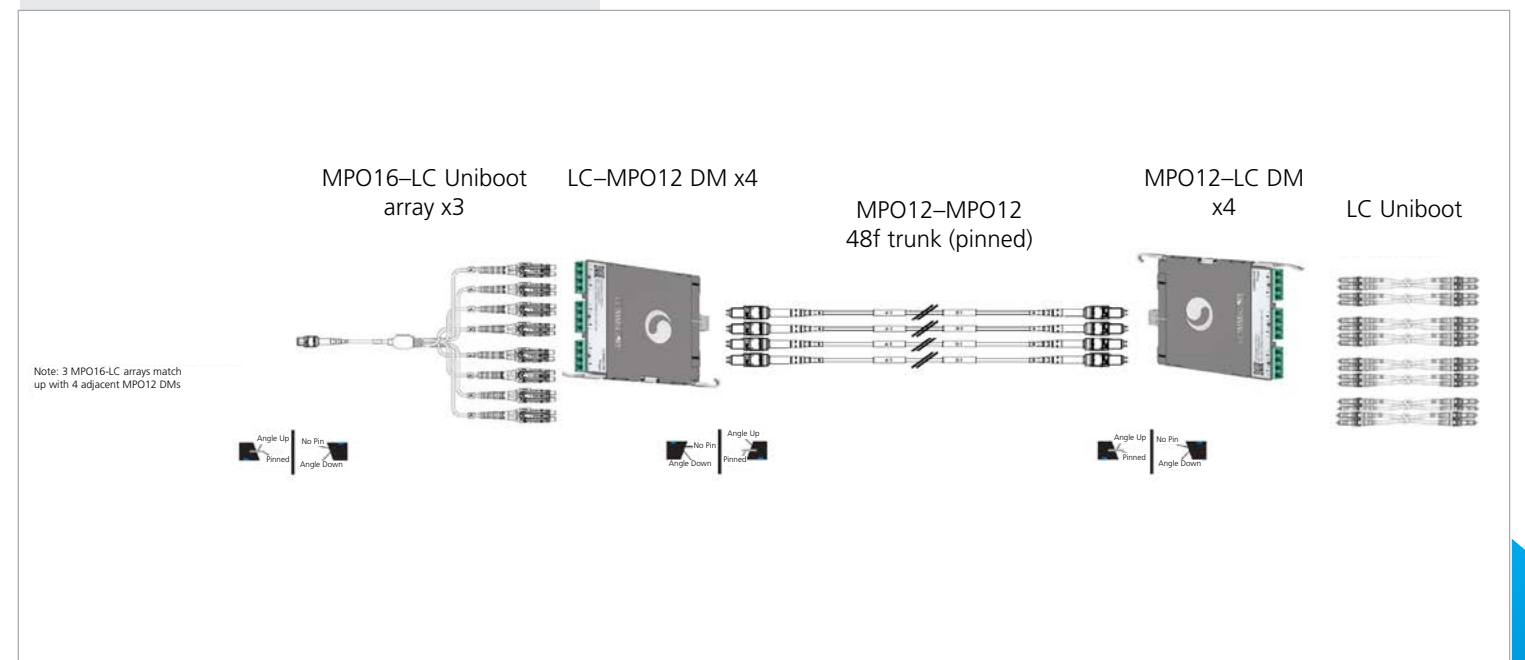

For panel ordering information, refer to panel annex in the back of this guide.

MPO12 singlemode APC assemblies

MPO12 singlemode APC trunk cables

1 U	2 G	3 G	4 M	5 X	6 M	7 X	8 C	9 D	10 -	11 J	12 J	13 F	14-16 010
Construction type U Ultra-low loss	Cable family 3 Trunk, LSZH CPR B2ca G Trunk, Plenum J Trunk, Dual Rated (OFNR/LSZH)	Fiber type G Singlemode (A2)	Connector 1 MX 12f MPO (Pinned)	Connector 2 MX 12f MPO (Pinned)	Cordage size C 12f PmP Trunk, 2.0mm SU	Fiber count D 12-fiber F 24-fiber G 36-fiber H 48-fiber K 72-fiber L 96-fiber M 144-fiber N 192-fiber P 288-fiber	Color J Yellow	Breakout length J 22" Break Propel No Pull Grip K 22" Break Propel Pull Grip	UOM F Feet M Meter	Length 010-999 ft 003-305 m			

MPO8 singlemode APC array cords

1 U	2 Q	3 G	4 Q	5 P	6 L	7 U	8 F	9 8	10 -	11 J	12 D	13 F	14-16 010
Construction type U Ultra-low loss	Cable family Q Plenum Array R Dual Rated (OFNR/LSZH)	Fiber type G Singlemode (A2)	Connector 1 QP 8f MPO MM APC (Non-pinned)	Connector 2 LU LC Uniboot	Cordage size F 8f PmP Array Cord, 2 mm	Fiber count 8 8-fiber	Color J Yellow	Breakout length D 12" E 24" H 48" L 72"	UOM F Feet M Meter	Length 12 in 3-999 ft 24 in 4-999 ft 48 in 6-999 ft 72 in 8-999 ft 12 in 1-305 m 24-48 in 2-305 m 72 in 3-305 m			

SYSTIMAX Uniboot patch cords

1 U	2 D	3 G	4 L	5 U	6 6	7 2	8 -	9 X	10 F	11-12 010
Construction type U Ultra-low loss	Cable family D Plenum F LSZH/Riser	Fiber type G Singlemode (A2)	Connector 1 LU LC Uniboot	Connector 2 LU LC Uniboot	Cordage size K 1.5 mm 6 2.0 mm	Fiber count 2 2-fiber	Color J Yellow	Breakout length X No breakout	UOM F Feet M Meter	Length 2-200 Feet 1-061 Meters

• Other lengths available please contact CommScope

	Material ID	Product Number	Description	Fiber Type	Fiber Count	Front Interface	Rear Interface
MPO12 modules							
12 per 1RU	760252345	PPL-DM-12AU-12LC-SM-BEU	Propel ULL Distribution Module, Method B Enhanced	OS2	12	6 duplex LCs with internal shutters	1 MPO12/APC non-pinned with internal shutter

400GBASE-DR4 to 4x100GBASE-DR (500m)

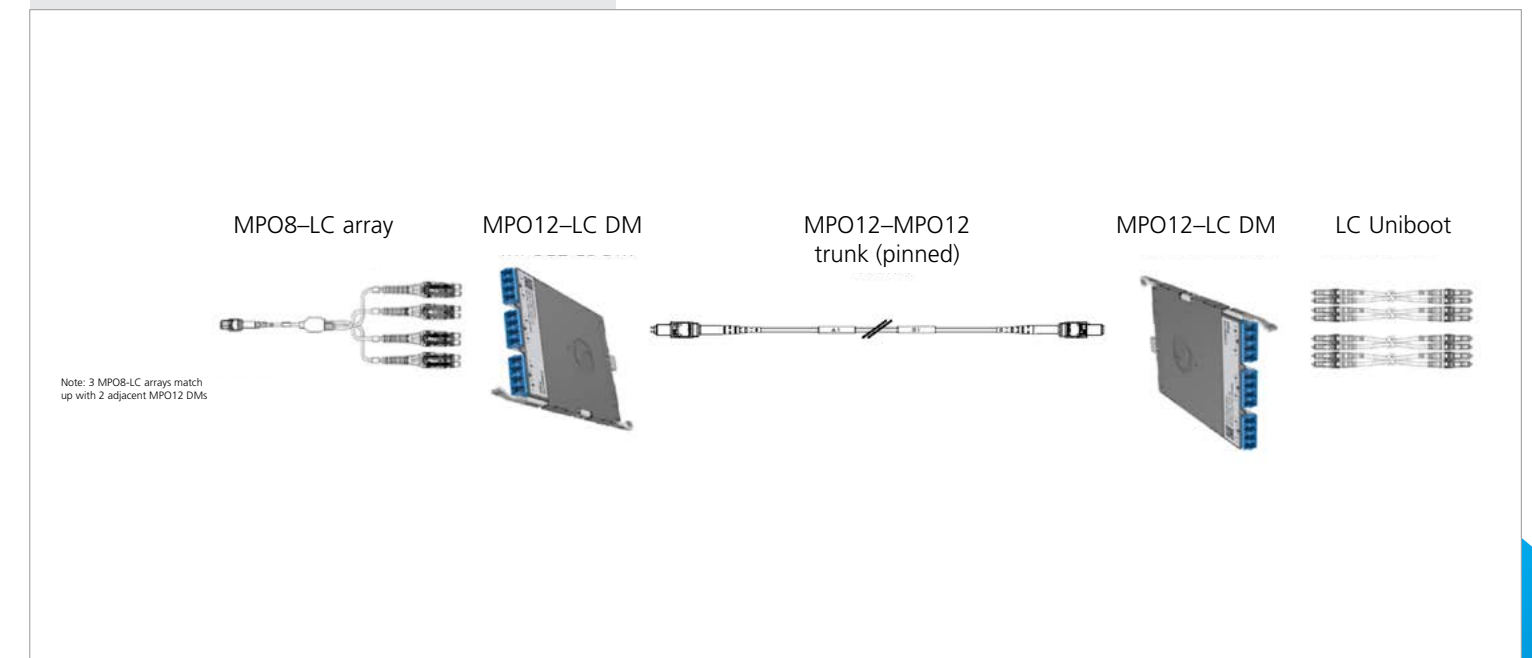

For panel ordering information, refer to panel annex in the back of this guide.

MPO12 Basic Channel

MPO12 UPC basic channels

Propel MPO12 ULL Multimode OM4/OM5 Method B Enhanced Polarity – LC Duplex BASE

MPO12-MPO12 UPC trunk (pinned)

Supports duplex applications

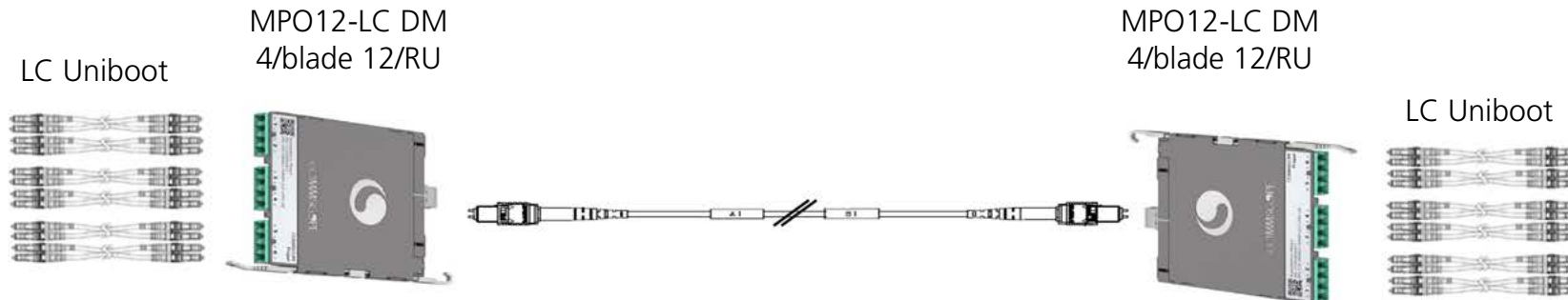

Supports QSFP 4 pr including BiDi applications over duplex base design

Requires 3 array cords for every 2 adjacent DMs

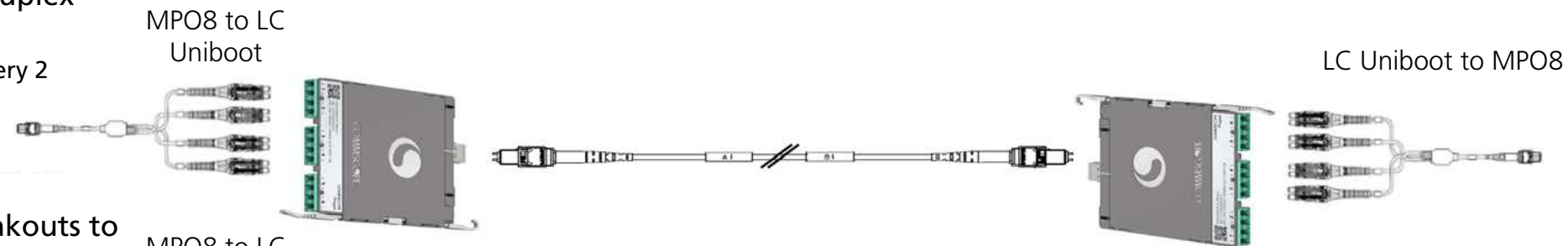

Supports QSFP 4 pr breakouts to duplex

Requires 3 array cords for every 2 adjacent DMs

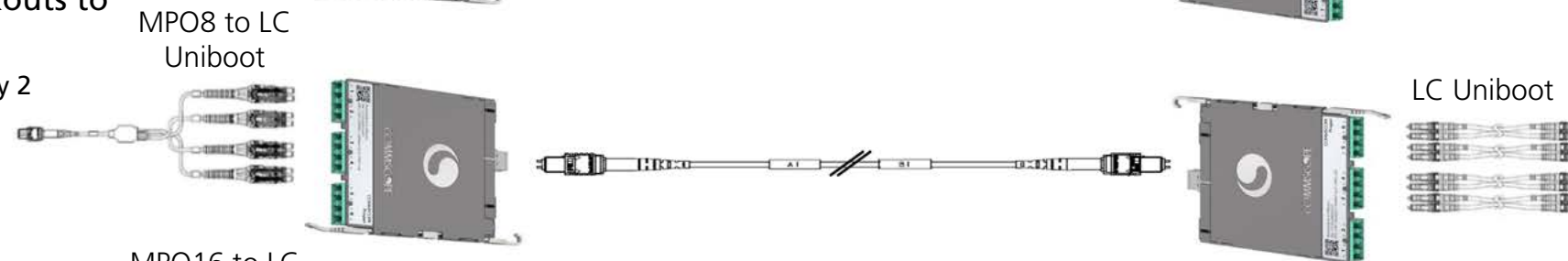

Supports SR8 applications over duplex base design

Requires 3 array cords for every 4 adjacent DMs

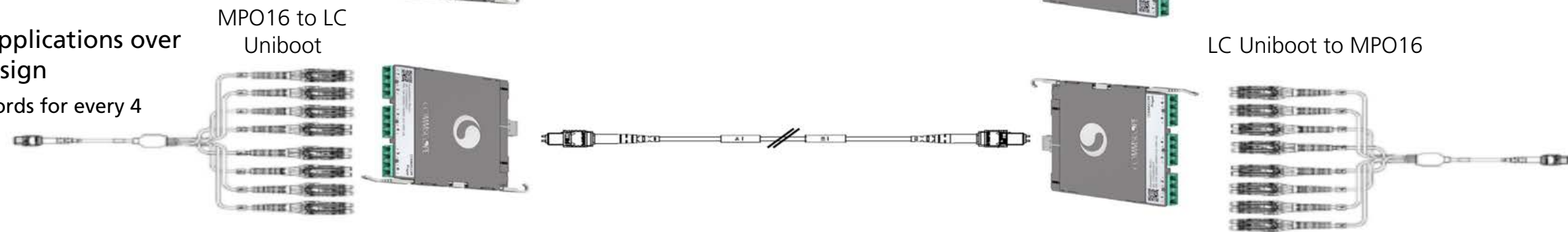

MPO12 UPC basic channels

Propel MPO12 ULL Multimode OM4/OM5 Method B Enhanced Polarity – MPO Adapter BASE

MPO12-MPO12 UPC trunk (pinned)

Supports QSFP 4 pr applications

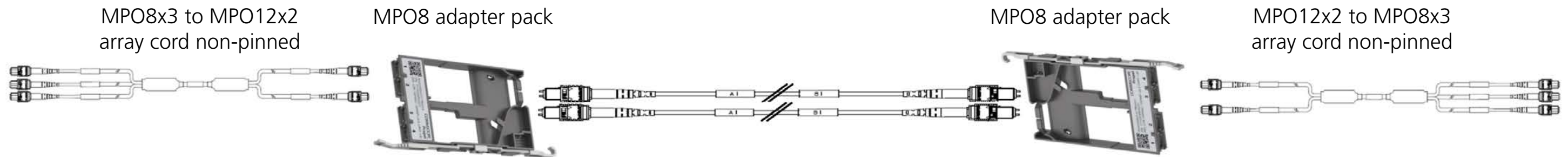

Supports 3x SR8 applications

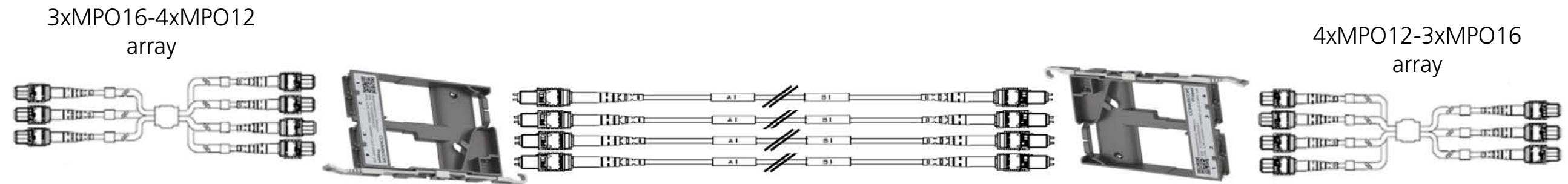

MPO12 APC basic channels

Propel MPO12 ULL Singlemode Method B Enhanced Polarity – LC Duplex BASE

MPO12-MPO12 APC trunk (pinned)

Supports duplex applications

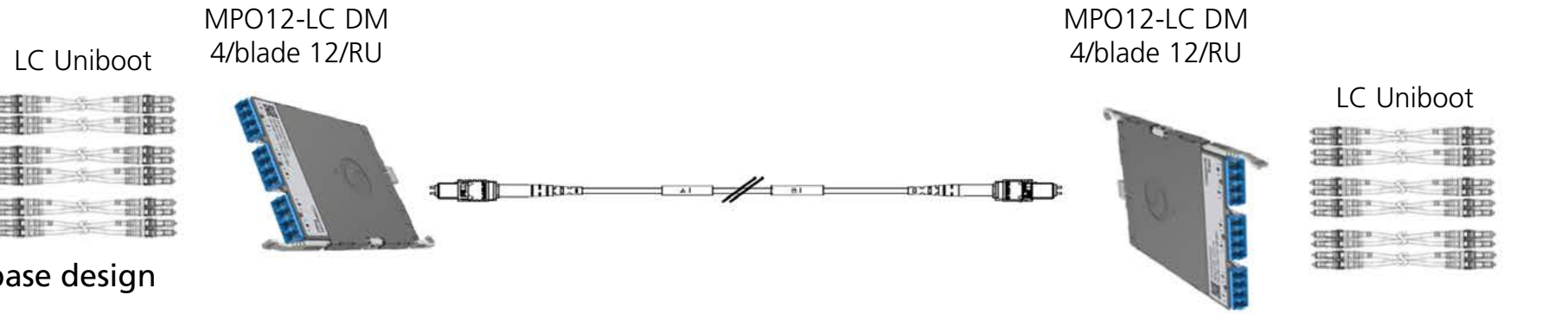

Supports QSFP 4 pr duplex base design
Requires 3 array cords for every 2 adjacent DMs

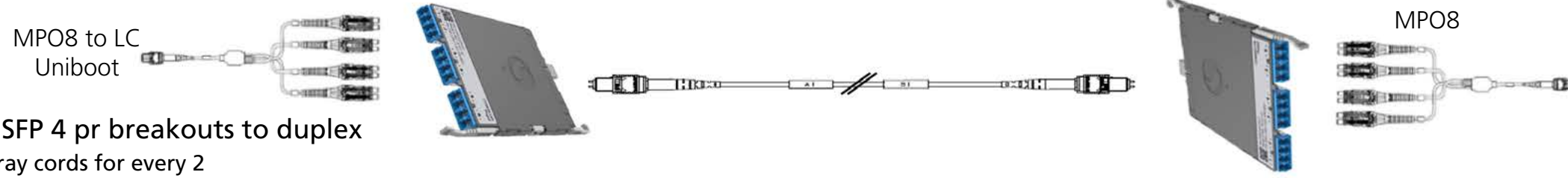

Supports QSFP 4 pr breakouts to duplex
Requires 3 array cords for every 2 adjacent DMs



Supports DR8 applications over duplex base design
Requires 3 array cords for every 2 adjacent DMs

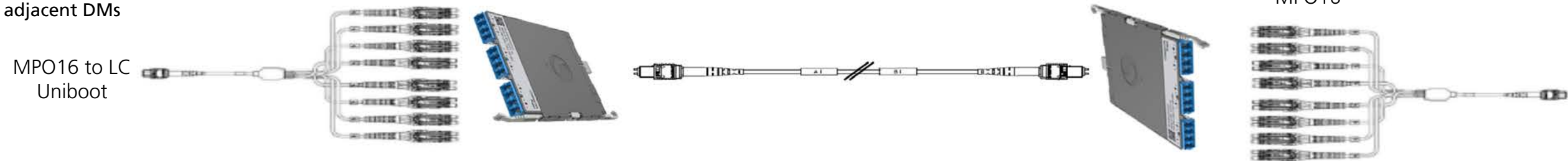

MPO12 APC basic channels

Propel MPO12 ULL Singlemode Method B Enhanced Polarity – MPO Adapter BASE

MPO12-MPO12 APC trunk (pinned)

Supports 3x 4 pr QSFP applications

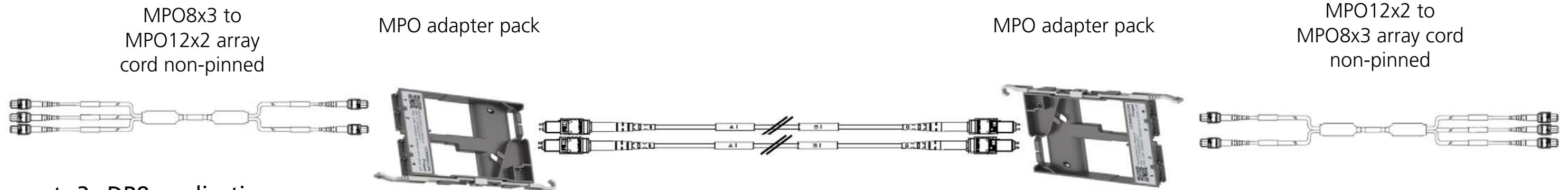

Supports 3x DR8 applications

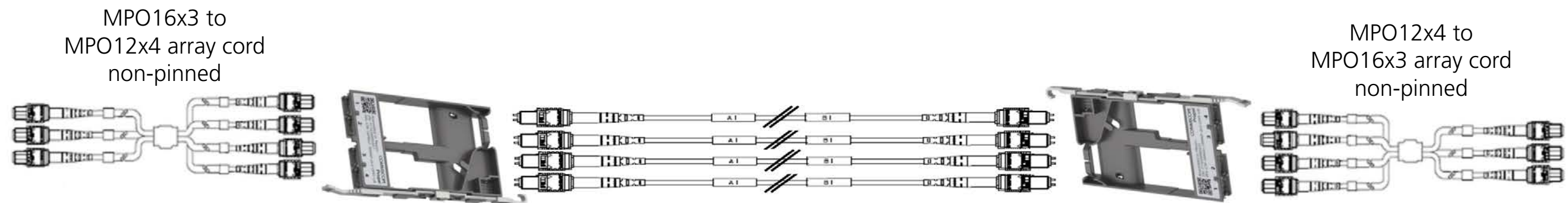

MPO24 Basic Channel

MPO24 UPC basic channels

Propel MPO24 ULL Multimode OM4/OM5 Method B Enhanced Polarity – LC Duplex BASE

MPO24-MPO24 UPC trunk (pinned)

Supports duplex applications

LC Uniboot

MPO24-LC DM
2/blade 6/RU

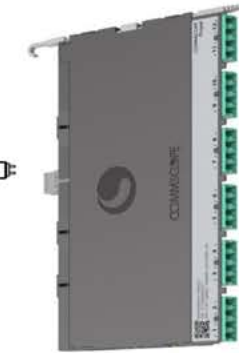
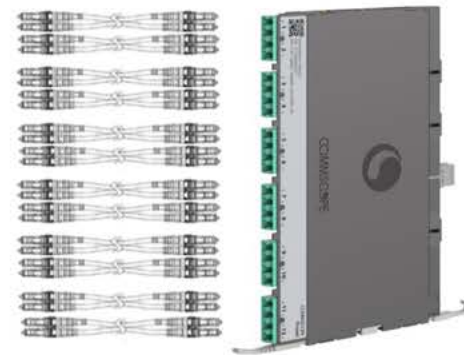

LC Uniboot

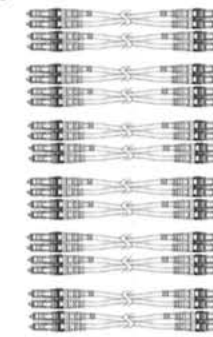

Supports 3x QSFP 4 pr applications
to breakouts

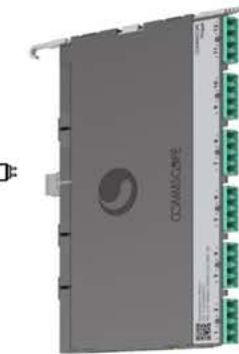
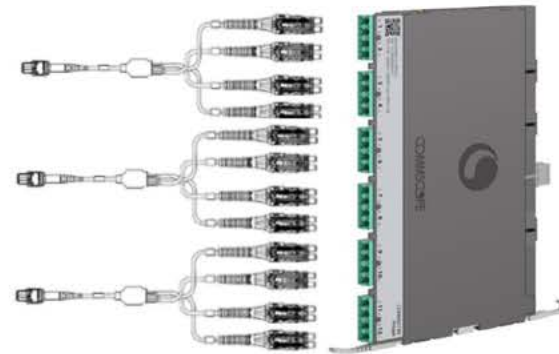

LC Uniboot

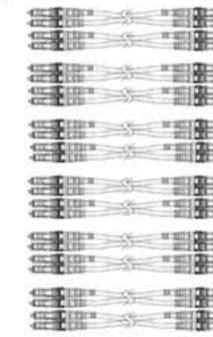

Supports 8 pr QSFP-DD applications
to lane breakouts
Requires 3 array cords for every
2 adjacent DMs

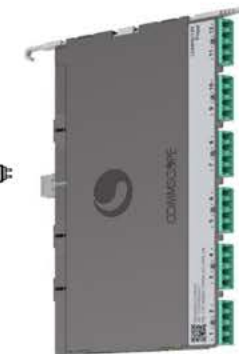
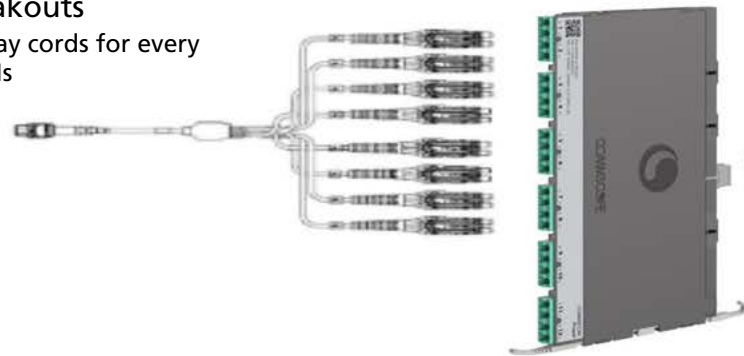

LC Uniboot

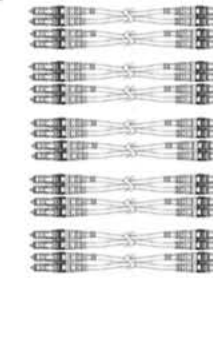

MPO24 UPC basic channels

Propel MPO24 ULL Multimode OM4/OM5 Method B Enhanced Polarity – MPO Adapter BASE

MPO24-MPO24 UPC trunk (pinned)

Supports 3x QSFP 4 pr applications

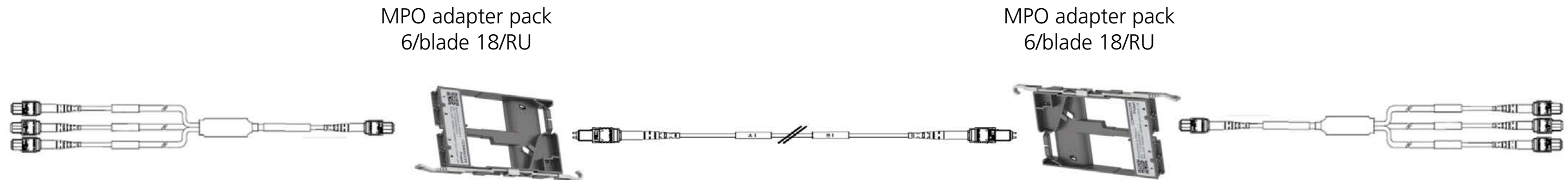

Supports 3x QSFP-DD SR8 applications

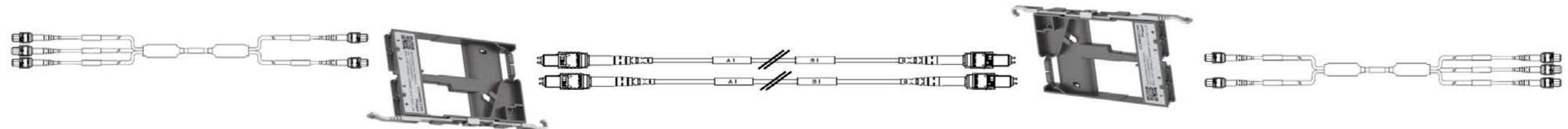

CS Solutions

Singlemode CS-LC Uniboot

Item	Product Number	Description
1	UDGLUCS62-JXFxxx or JXMxxx	ULL SM A2 CS to LC Uniboot 2f patch cord, Plenum
	UFGUCS62-JXFxxx or JXMxxx	ULL SM A2 CS to LC Uniboot 2f patch cord, Dual Rated (OFNR/LSZH)

400GBASE2FR4 to 2x200GBASEFR (2 km)

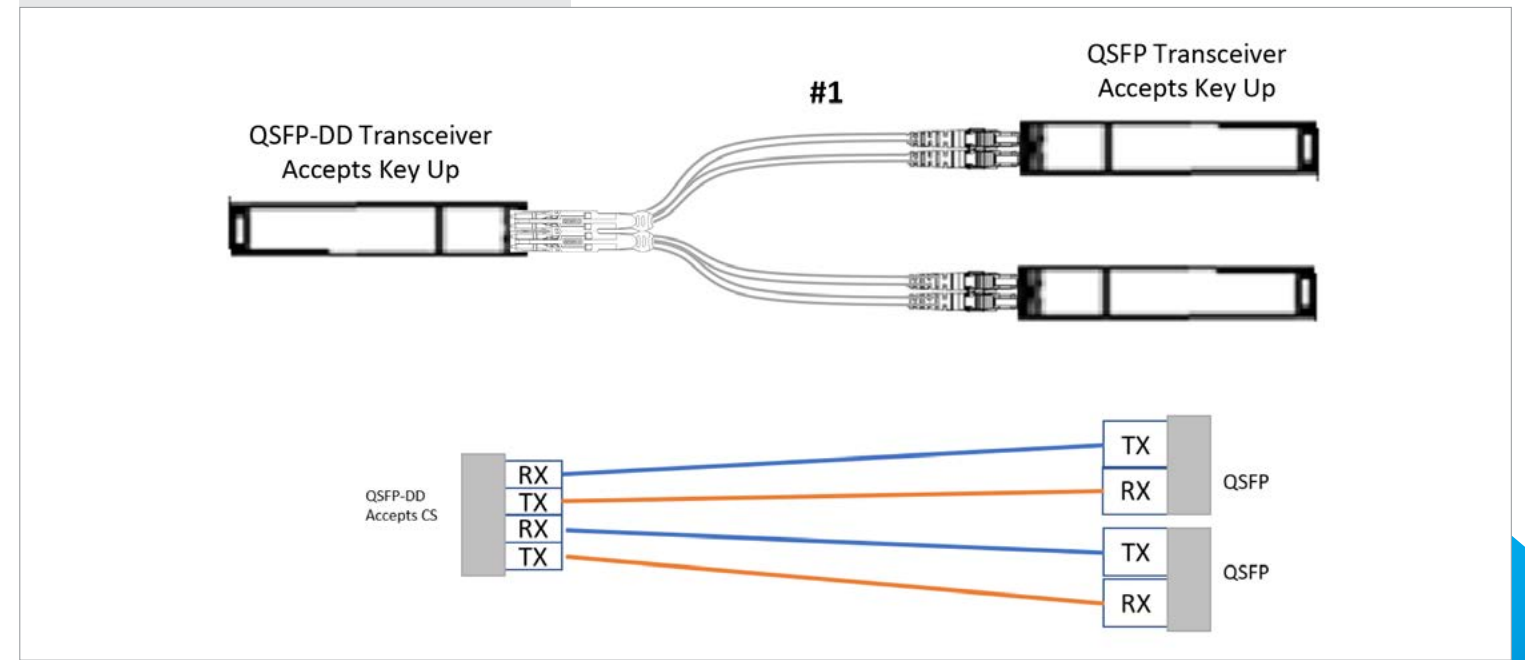

For panel ordering information, refer to panel annex in the back of this guide.

Panel Annex

High-density panels

Propel high-density panels are designed to adapt and grow as your needs change. Like all Propel components, the panels are completely modular and interchangeable. They support 16-fiber connectivity and up to 144 LC-connected fibers per RU—giving you the flexibility and density to seamlessly advance to 400 Gb, 800 Gb and beyond.

Propel panels incorporate unique design features that make them faster to deploy and easier to manage than older generation panels. For example, panel blades can be removed with one hand for easier maintenance and changes by a single technician. When inserted, the blades lock in place on both sides to provide more secure patching. A re-designed rear cable management system allows more cable to be securely stored and attached.

At the same time, each panel is highly versatile. Module and adapter pack sizes can be scaled or mixed in each panel or blade.



Material ID	Product Number	Description	Height (in/mm)	Width (in/mm)	Depth (in/mm)	Weight (lbs/kg)	Density
760252002	PPL-1U	Propel 1RU sliding panel	1.75/44	19/483	18.52/470	11.7/5.3	72 duplex LC, 72 MPO, 144 SN
760252003	PPL-2U	Propel 2RU sliding panel	3.50/89	19/483	18.52/470	17.3/7.9	144 duplex LC, 144 MPO, 288 SN
760252004	PPL-4U	Propel 4RU sliding panel	7.00/178	19/483	18.52/470	30.5/13.8	288 duplex LC, 288 MPO, 576 SN

Modules and adapter packs per blade

Product Number	8-fiber modules/adapter packs	12-fiber modules/adapter packs	16-fiber modules/adapter packs	24-fiber modules/adapter packs
PPL-1U	up to 6 per blade/18 per panel	up to 4 per blade/12 per panel	up to 3 per blade/9 per panel	up to 2 per blade/6 per panel
PPL-2U	up to 6 per blade/36 per panel	up to 4 per blade/24 per panel	up to 3 per blade/18 per panel	up to 2 per blade/12 per panel
PPL-4U	up to 6 per blade/72 per panel	up to 4 per blade/48 per panel	up to 3 per blade/36 per panel	up to 2 per blade/24 per panel



CommScope pushes the boundaries of communications technology with game-changing ideas and ground-breaking discoveries that spark profound human achievement.

We collaborate with our customers and partners to design, create and build the world's most advanced networks. It is our passion and commitment to identify the next opportunity and realize a better tomorrow.

Discover more at commscope.com.

COMMSCOPE®

commscope.com

Visit our website or contact your local CommScope representative for more information.

© 2022 CommScope, Inc. All rights reserved. All trademarks identified by ™ or ® are trademarks or registered trademarks in the US and may be registered in other countries. All product names, trademarks and registered trademarks are property of their respective owners. This document is for planning purposes only and is not intended to modify or supplement any specifications or warranties relating to CommScope products or services.