

TC-442-IP

Rev A, Mar 2017

www.commscope.com

Fibre Optic Splice Closure with integrated organiser system

1 General

1.1 The installation instruction describes the necessary steps to install the FOSC-400B2 & B4. The used optical fiber cables may consist of a loose tube, slotted core, central core or ribbon construction depending on the type of FOSC kit. Illustrated are the loose tube construction and fusion splicing protected by heat-shrinkable splice protectors.

1.2 The FOSC-400B2 & B4 kit is supplied with one splice tray organiser. One tray (S24) can accommodate up to 24 fiber splices, depending the type of tray. Supplementary tray kits may be used (up to 3 extra trays maximum per closure).

1.3 All splice trays accommodate fusion splice protection types such as TE Connectivity SMOUV-1120-serie and some types of trays (S12) most common types of mechanical splices. (GTE, FIBRLOK or other similar products).

1.4 FOSC-400B2 & B4 closure system has one oval cable entry port which can handle 2 cables e.g. looped cable. The FOSC-400B2 has two big circular ports and the FOSC-400B4 has four small ones.

1.5 The seals may only be installed with hot air (hot-air temperature should be at least 350°C). An open flame is not allowed.

1.6 The FOSC-400B2 & B4 can be installed in direct buried, manholes or aerial locations.

1.7 The kit contents listed in this installation instruction reflect the standard contents. Alternative configurations are possible.

2 Product description

2.1 Product designation

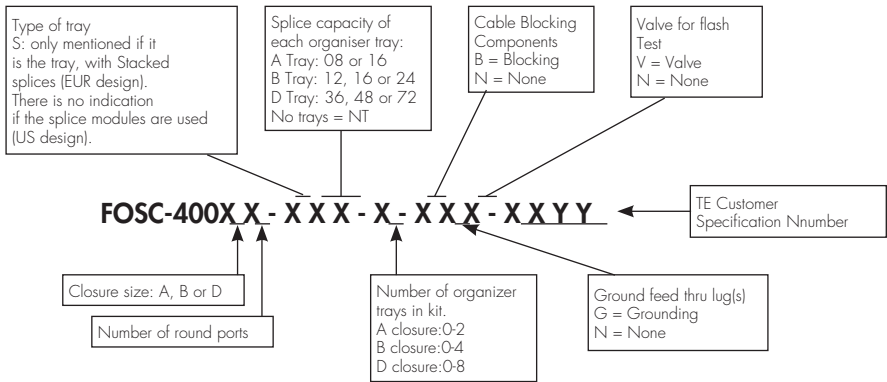

Ex. FOSC-400B4-S12-1-NNN-BA01

- B4 B size with 4 small diameter ports
- S12 Tray for up to 12 stacked splices
- 1 Closure is delivered with 1 tray
- NNN The closure is not equipped for cable blocking, has no valve for flash test and has no special components for electrical grounding
- BA01 Customer control number

FOSC sizing information (dimensions in mm)

TE in description	Total closure length	Outer dia		Max.fusion splice capacity (250µ fibers)	Cable diameter			
		closure			Circular port		Oval	
		min. (body)	Max. (body + clamp)		min. (*)	max. (*)	min. (**)	max. (**)
FOSC-400A4	420	152	205	32	5	19	10	25
FOSC-400B2	540	152	205	96	5	32	10	25
FOSC-400B4	540	152	205	96	5	19	10	25
FOSC-400D5	710	240	285	576	5	32	10	25

(*) Cable diameter for 1 cable/port

(**) Cable diameter for 2 cables/port

2.2 Content FOSC-400B2&B4-XXX-1-NNNN

- Dome
- Clamp
- Base with strength member connections and one tray assembly (see 2.3.1.)
- Hook and loop fastener strip
- Tray support wedge
- Oval outlet seal kit (see 2.3.3.)
- Shield continuity wires
- Shield continuity connector
- Installation instruction
- Sealing ring



2.3 Examples of supplementary kits

2.3.1 Tray kit

FOSC-B-TRAY-S12-1

- Tray for 12 splices
- Tray lid
- Tie-wraps
- 4 small transportation tubes (id=2,0 mm)
- 4 large transportation tubes (id=2,8 mm)

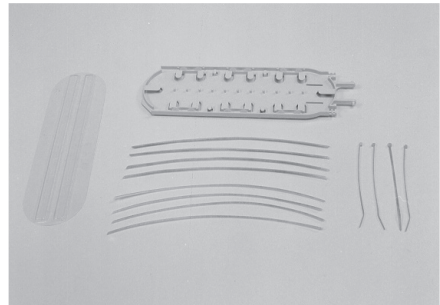

2.3.2 Cable seal-kit

FOSC-B/DCSEAL-1-NT

- Aluminium cable protection tape
- Heat-shrinkable cable sleeve
- Cleaning tissue
- Abrasive strip
- * Shield continuity wire*
- * Shield continuity connector*
- * Installation instruction*



2.3.3 Oval outlet cable seal kit

FOSC-B/DCSEAL-2-NT

- Heat shrinkable sleeve
- Branch-off clip
- Aluminium cable protection tapes
- Abrasive strip
- Cleaning tissues
- * Shield continuity wires*
- * Shield continuity connector*
- * Installation instruction*

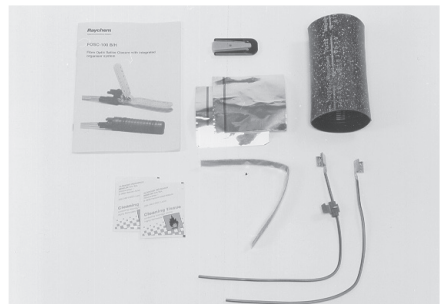

* Only included if the seal kits are ordered separately.

2.3.4 Re-entry kit
FOSC-A/B-ORING-SEALKIT

- Desiccant
- Sealing ring
- Cleaning tissue



2.4 Accessory kits

2.4.1 FACC-HEAT-GUN-220V
Hot air gun CV 1981 (1460 Watt) and
Reflector PR 26.
Min. required hot-air temperature: 350°C.



2.4.2 FOSC-A/B-POLE-MOUNT.
Mounting kit.
Accessories for pole mounting or wall fixing.

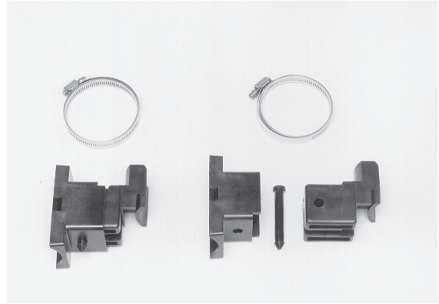

2.4.3 FOSC-B-BASKET-LBT
Loose buffer tube slack tray.
Accessory to store uncut or extra length. Loose
Buffer Tube.



2.4.4 FOSC-A/B-VAULT-BAG
Flame retardant bag to cover closure for vault application.

2.4.5 FOSC-WORK-STAND
FOSC holder device.

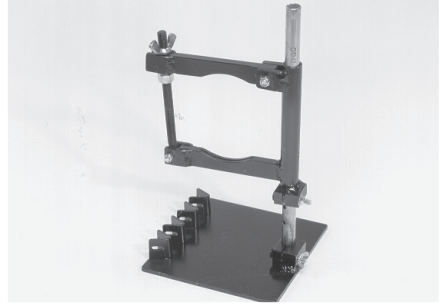

3 General precautions

- 3.1 Do not use damaged sleeve nor trim heat-shrinkable sleeve before installation.
- 3.2 The FOSC-400B2&B4 closures can be installed at temperatures between -1°C and +45°C.
- 3.3 Generators used should have enough capacity for the hot air gun utilisation.

Optical fiber infrastructure network elements may contain end of optical fiber attached to the optical output when the device is operational. Laser radiation can seriously damage your eyesight. Please follow your local safety guidelines.

4 Cable installation in oval outlet

4.1 Loosen the clamp. Push the lever down to release the locking tab. Open the clamp lever and release the clamp using the lever legs. Remove the clamp, dome and sealing ring and store carefully for later use.

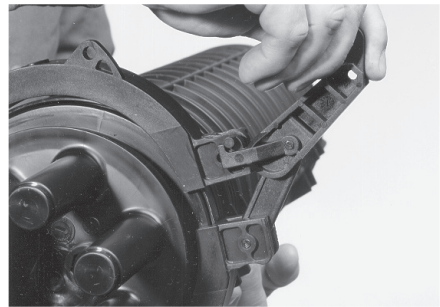

4.2 Install the FOSC in the FOSC-STAND and open the oval port for cable entry by cutting the port at the ridge with a hacksaw. Deburr the inner edge of the port opening with abrasive strip.

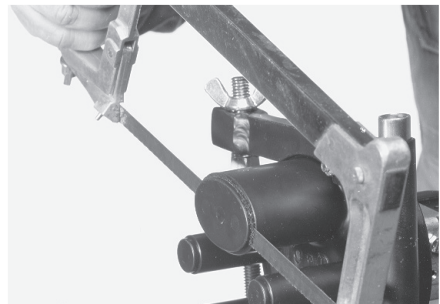

4.3 Remove any dirt, mud or other contaminants from the cable sheath for approximately 2 meters with a clean cloth. Take the oval cable seal and slide it over the cables. The non-coated edge of the sleeve and the arrows should be pointed to the base of the closure.



4.4 Slide the cables through the opened oval port. Prepare cables as described in section 5 (cable preparation).

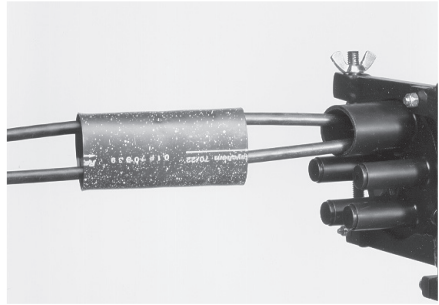

5 Cable preparation

5.1 Remove the cable sheath (and shield if present) over a length as required by locally approved practice (e.g. 1,2 meters). 1.1 m is the maximum allowed length if the ribbon (6R4) or high capacity trays (S24) are used. Clean filling compound from fiber tubes and cut central strength member at a distance of 75 mm from outer jacket.



5.2 If a shield continuity is required, cut cable sheath axially for 25 mm from cable ring cut. Crimp shield clip on cable sheath with pair of pliers. Protect the clip with self adhering tape.

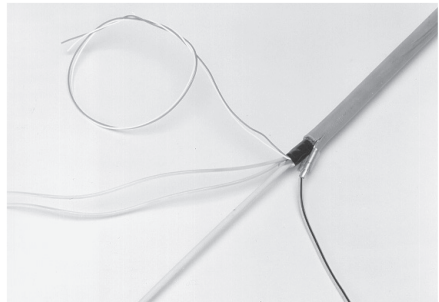

5.3 Cut the loose tube, at a distance of 35 mm from the cable ring cut and remove and degrease fiber bundle. Select a transportation tube which fits over the loose tube. Slip transportation tube over fibers and the loose tube.

Note: for slotted core cable: use an appropriate kit which converts the slotted cable construction into a loose tube construction.

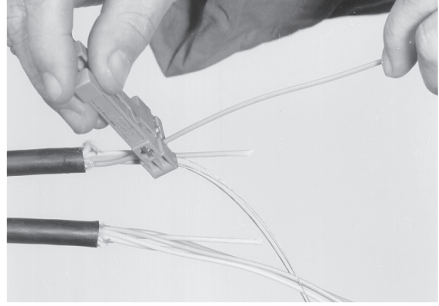

5.4 Align cable ring cuts with edge of base.

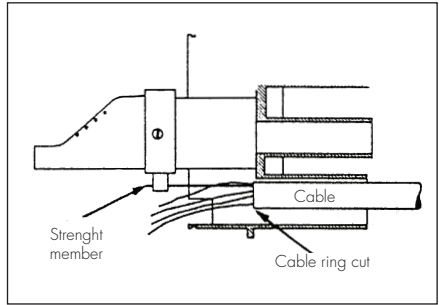

5.5 Slide strength members into clamps and tighten. Cut away the excess length of strength member.

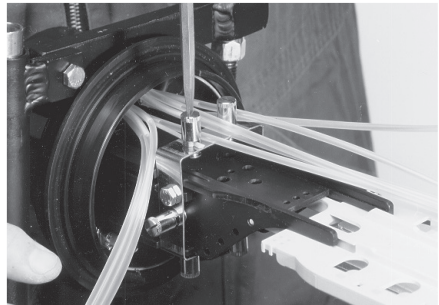

5.6 If required, connect shield continuity wire of both cables with shield continuity clip. Talk pairs, if present, will be connected together according to the local procedures.

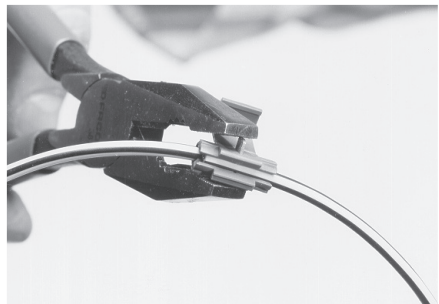

6 Sealing of oval outlet

6.1 Thoroughly clean oval port and cable sheath with the cleaning tissue over a distance of 100 mm from the edge of the port.



6.2 Abrade oval port and cable sheath circumferentially on the cleaned area with the abrasive strip. Remove any abraded material with a clean cloth.

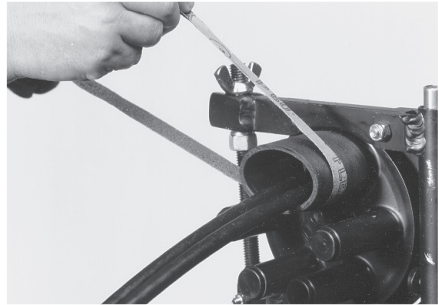

6.3 Place oval seal over the oval port and cable. Mark the sleeve length onto the cable.



6.4 Match the blue line of the aluminium cable protection foil with the marks on the cables. Wrap aluminium cable protection foil around cable.

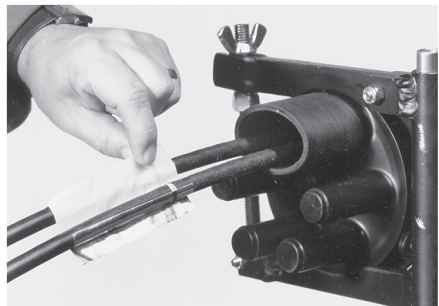

6.5 Slide the oval cable seal over the oval port. Install the branch-off clip. Check that the heat-shrinkable sleeve butts up against the FOSC-base and the branch-off clip is completely inserted. Tape the two cables together.



6.6 Shrink the oval cable seal on the FOSC-base side with the recommended hot air gun device with reflector. Shrink sleeve until the green thermo-indicating paint is converted to black. (Make sure the hot-air temperature is at least 350°C). (If a FACC-HEAT-GUN-220V is used, set position on scale 10).



6.7 Shrink down the end of the sleeve on the cable side. Heat until the sleeve shrinks down on the cables and take care that the green thermo-indicating paint is converted to black. Postheat the clip on both sides till the adhesive shows a proper flow on the clip between the two cables.

Wait until the sleeve is cool to the touch before moving the cables.

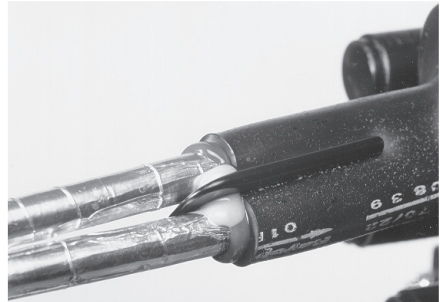

7 Organisation of the fibers

7.1 If a FOSC-B-TRAY-S12-1 is used. Tray for up to 12 splices

7.1.1 Each splice tray accommodates 12 fiber splices maximum and each side of the tray holds a maximum of 4 big transportation tubes or 6 small transportation tubes. Position the transportation tubes on bottom tray and align the tubes along the tray. Place a mark on each tube on tray side at 15 mm from tray edge.

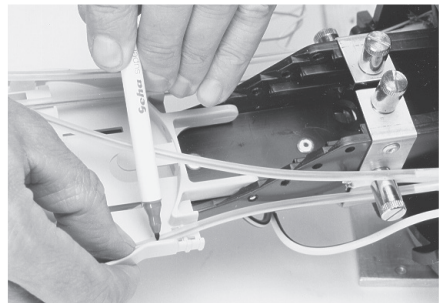

7.1.2 Carefully cut the transportation tubes at the mark and secure to splice tray with two tie wraps. The transportation tube may not be in contact with fibers stored in the organizer. Other tubes should be laid out of the way of the bottom tray. Alternatively, additional trays may be installed to store the fibers (see section 9). Cut the transportation tubes in the organiser/ tray. Always place transparent cover over tray.

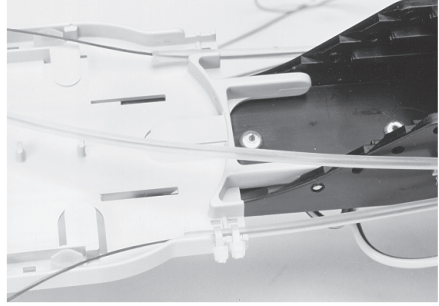

Splicing and fiber storage

7.1.3 Position the FOSC-400B2&B4 by the splicing machine in a convenient location, and secure the closure.

7.1.4 Slide the heat-shrinkable splice protection over one fiber and fuse fibers according to local recommendations and procedures. After the fusion splice is made, install the heat-shrinkable splice protection (e.g. SMOUV) with appropriate heating source. Allow the splice protection to cool down to ambient temperature.

7.1.5 After each splice is made, the splice should be stored in the splice holder. Do not deform the splice protector during insertion. The fiber slack should be coiled into the tray.



7.1.6 For 12 fiber capacity tray, two fusion protection sleeves should be installed on top of one another in one splice holder.

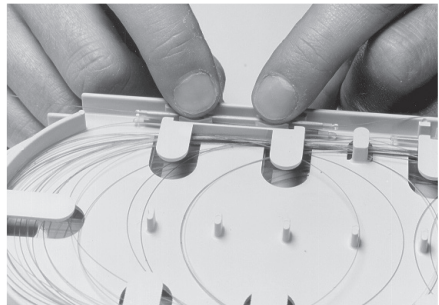

7.1.7 Upon completion of splicing, install the clear protective cover on the tray. Secure cover by installing the hook and loop fastener strip around the trays and cover.

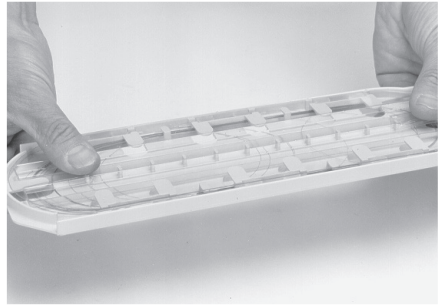

7.2 If a FOSC-B-TRAY-S24-1 is used. Tray for up to 24 short fusion splice protectors

7.2.1 The tray organiser has 6 positions to store splice protectors. Each position can hold maximum 4 fusion splice protectors of type SMOUV-1120-02 (length = 45 mm, installed outer diameter is 2,4 mm) or equivalent. Each side of the tray holds a maximum of 4 big or 6 small transportation tubes, see 7.1.1. **Make sure the cable has been stripped to a maximum length of 1.1 m.**

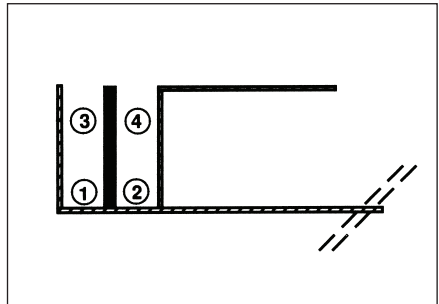

7.2.2 After each splice is made, the splice should be stored as indicated on the drawing (see 7.2.1.). First protector in position 1, the second in position 2. Continue for other fibers. Fiber n°5 will be in position 1 of next location. Coil the excess length of fiber each time you have positioned the splice protector.

7.3 If a FOSC-B-TRAY-6R4-1 is used. Tray for up to 6 ribbons of 4 fibers

7.3.1 The tray organiser has 6 locations in which spliced ribbon fiber (max. 4 fibers per ribbon) can be held. The base of the ribbon closure has ribbon fiber guiding clips which allow the ribbon to be directed to the organizer tray without touching the brackets of the strength member. Use the appropriate splice protection for ribbon construction (length = 40 mm) e.g. fiber protection sleeve FPS-5 Sumitomo, Fujikura FP-5 or equivalent. Make sure the ribbon cable has been stripped over a maximum length of 1.1 m. Guide the ribbon fibers through the fiber guiding clips and close the clips. Make sure the ribbons are not squeezed off while closing the clips.

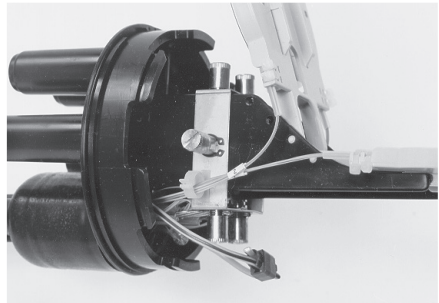

7.3.2 Group max. 6 ribbons per tray and slide the transportation tube over the ribbons (max. 3 ribbons/tube). Identify the group of fibers per cable.

7.3.3 Carefully secure the transportation tube to splice tray and secure with two tie-wraps per tray entrance. Temporarily store the ribbons into the tray. Proceed for all groups of ribbons.

7.3.4 Use appropriate fusion splice protector and slide it over one ribbon fiber. Splice and install splice protector according to the local procedure.

7.3.5 After cooling, the splice protector should be stored in the splice holder. The ribbon slack should be coiled into the tray.

To minimize the torsion of the ribbon after coiling it into the tray, it is recommended to precoil the ribbon before splicing. Two complete turns is the maximum.

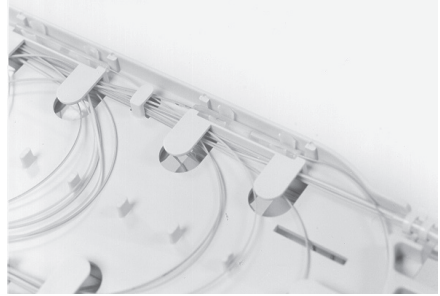

7.3.6 If, due to torsion, the minimum bending radius of 38 mm can not be maintained, rotate the splice protector such that the torsed length of the ribbon will be in the straight part of the organizer tray.

7.3.7 Proceed as from 7.1.3.

8 Tray kit

8.1 If additional trays are to be used, align the tray pins with the holes on base bracket. Squeeze tray pins and slip tray into bracket.

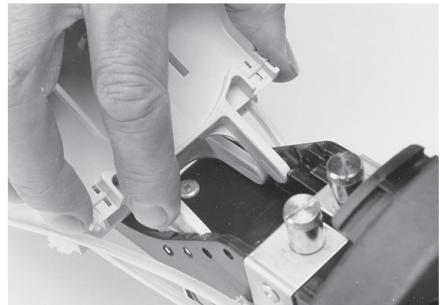

8.2 Proceed for fiber splicing as described from point 7. However, provide enough slack on transportation tube such that no severe bending or kinking of tube may occur during hinging.

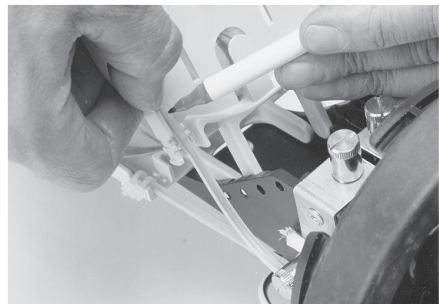

8.3 Use tray wedge to keep the tray in upward position.

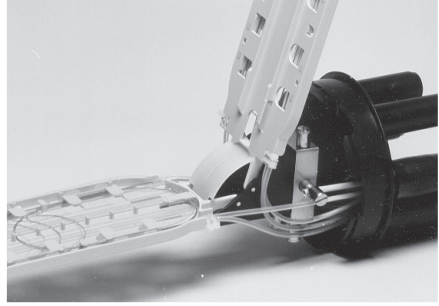

9 Dome installation

9.1 Open and remove the desiccant bag from its package and place the desiccant bag on the upper tray. Secure the trays and the desiccant bag with the hook and loop fastener strap.

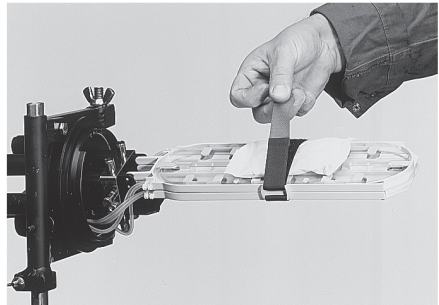

9.2 Ensure seal areas and sealing ring are clean and sealing ring is in place at the base.

Important.
Make sure the sealing ring is well positioned.

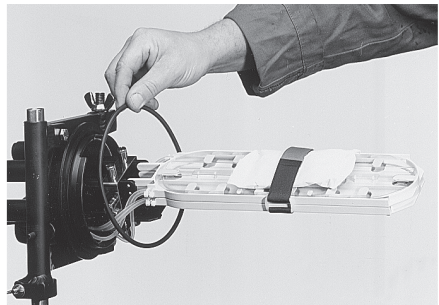

9.3 Place the dome carefully over the trays onto the base. Put the clamp around the base/dome interface.

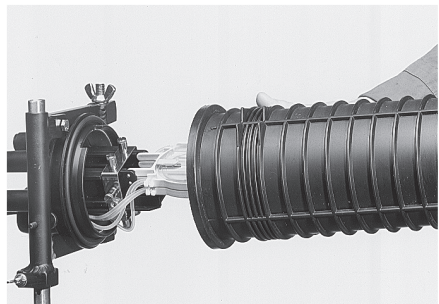

9.4 Close the clamp.

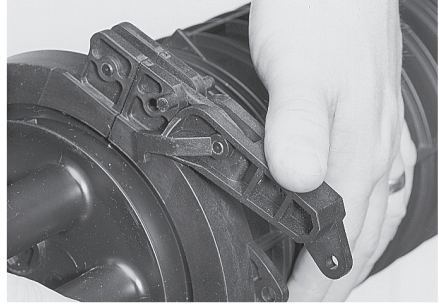

10 Re-entry

10.1 Remove the clamp.

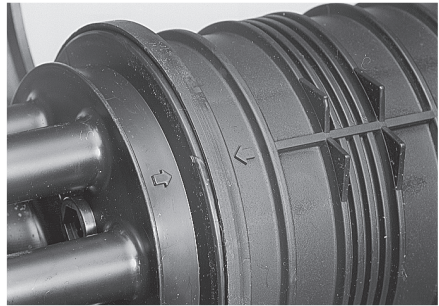

10.2 Remove carefully the dome avoiding damaging the sealing ring and fiber management.

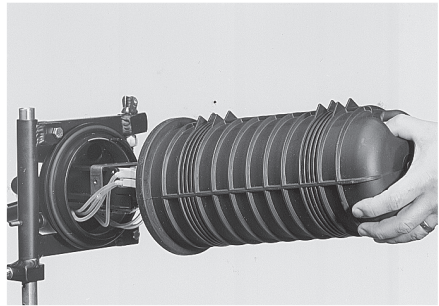

10.3 Remove gently the sealing ring. Keep the sealing ring and seal area of the closure free of dirt (if needed rinse with clear water).

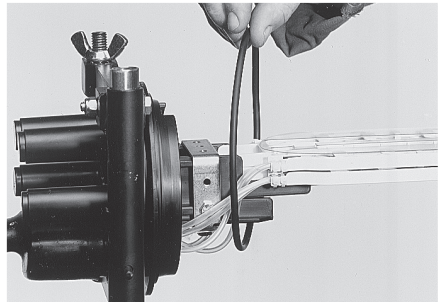

10.4 The dome may be reinstalled by following the procedure as described in section 9. Replace the 75 grams of desiccant. **The sealing ring has also to be replaced if damaged.** A new sealing ring and 75 gram of desiccant can be ordered: FOSC-A/B-O-RING-SEAL-KIT.

11 Cable installation in circular outlet

11.1 Open the port for cable entry by cutting the port at the ridge with a hacksaw. Deburr the inner edge of the port opening with abrasive strip.

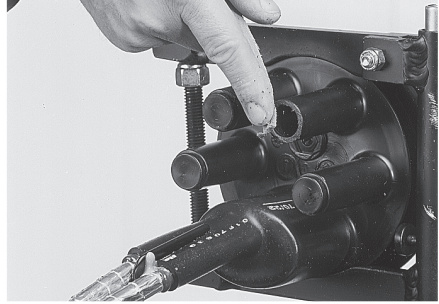

11.2 Remove any dirt, mud or other contaminants from the cable sheath for approximately 2 meters with a clean cloth. Take the cable seal sleeve from the kit FOSC-B/D-CSEAL-1-NT and slide it over the cable. The non-coated edge of the sleeve and the arrows should be pointed to the base of the closure.



11.3 Prepare the cable as outlined in section 5 "Cable preparation".

11.4 Slide the prepared cable through the opened entry port and install the transportation tubes described in section 5.

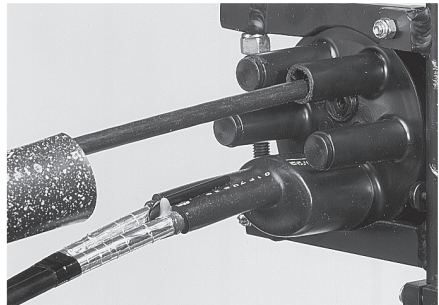

11.5 Align cable ring cut with the edge of the base. Slide strength member into clamp and tighten the nut. Cut away the excess length of strength member.

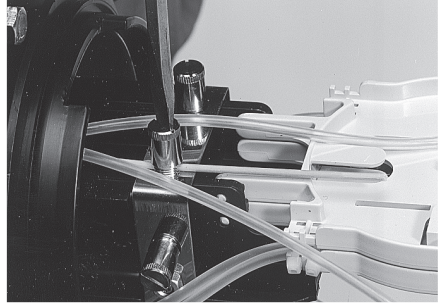

11.6 Thoroughly clean port and cable sheath with the cleaning tissue over a distance of 100 mm from the edge of the port.

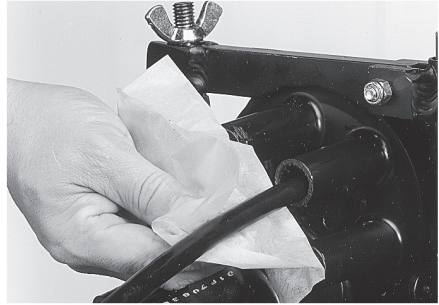

11.7 Abrade port and cable sheath circumferentially on the cleaned area with the abrasive strip. Remove any abraded material with a clean cloth.

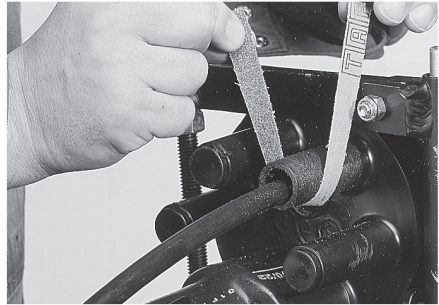

11.8 Place cable seal over the drop outlet of FOSC base. When cable seal butts against the base, mark the sleeve length on cable sheath.

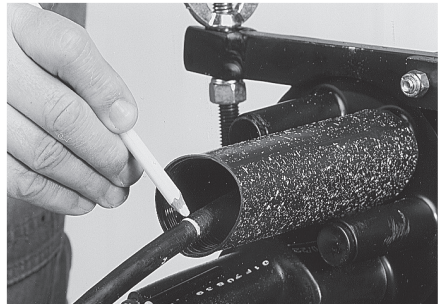

11.9 Match the blue line of the aluminium cable protection foil with the marks on the cables. Wrap the aluminium cable protection foil around cable.



11.10 Slide the cable seal over the port. Shrink the cable sleeve on the base side with the recommended hot air gun. Use the reflector to ensure heat distribution around the outlet. Shrink sleeve until the green thermo-indicating paint is converted to black.

Note: setting of the thermogun: FACC-HEAT-GUN-220V in position 10. Minimum hot air temperature should be 350°C.

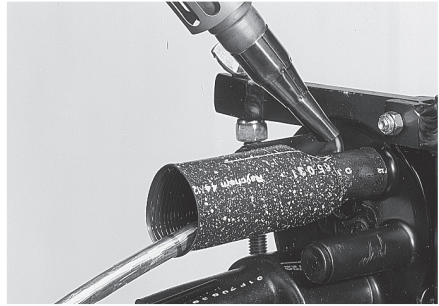

11.11 Shrink down the end of the sleeve on the cable side. Heat till the sleeve shrinks down onto the cable and the green thermo-indicating paint is converted to black. A ring of red adhesive should be visible at the cable on the end of the sleeve.

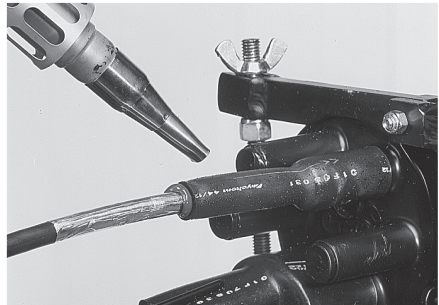

11.12 **Wait until the sleeve is cool to the touch before moving the cables.**



11.13 After completion of splicing, re-install the dome and sealing ring (see section 9).

12 Additional cable installation

12.1 For each added cable use a FOSC-B/D-CSEAL-1-NT. For each added cable proceed as per section 11.

12.2 After completion of splicing, re-install the dome and the sealing ring (see section 9).

13 Other capabilities of splice holder

13.1 Short splices
(e.g. TE Connectivity SMOUV 1120-02 and -03).

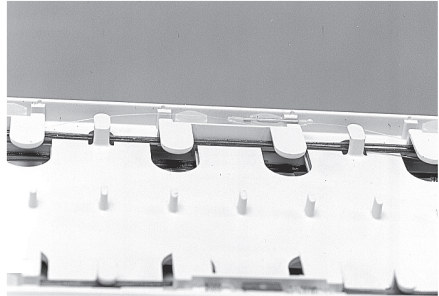

14 Mounting kit

14.1 Position the two dome mounting brackets on the dome of FOSC-A/B-POLE-MOUNT. Clamp the brackets into the pole mounting brackets and secure it with the locking pin.

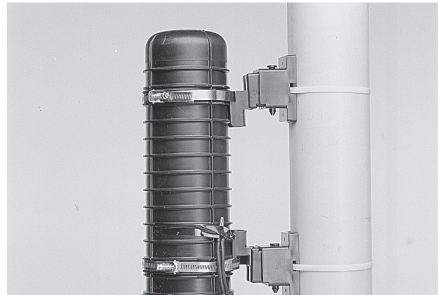

15 Slack tray

15.1 Detach the organizer tray from the FOSC base by squeezing the tray pins and slip the tray out of the bracket.

15.2 Turn the closure on its side and install the loose tube slack tray with the open side downwards. The ribs of the base are positioned in the grooves of the slack tray and the holes of the bracket are matching the holes of the slack tray.

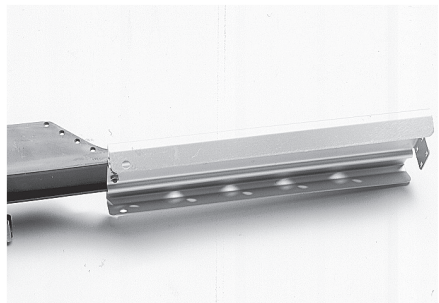

15.3 Attach the slack tray with the nuts and bolts. Tighten the nuts. Re-install the bottom tray by aligning the tray pins with the bottom holes of the bracket. Squeeze tray pins and slip tray into the bracket.

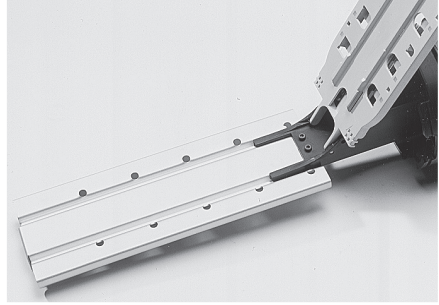

15.4 For storing the uncut loose buffer tubes, slide the loose tubes through the oval port, being careful not to kink the tubes. Store the loose tube into the basket and secure in place with tie-wraps.

16 Intertray jumpers

16.1 When it is necessary to splice fibers that are placed on different splice organizer trays an intertray jumper may be used to route one or more fibers to the desired tray.

16.2 Secure one end of intertray jumper tube to the splice tray and secure with two tie-wraps.

16.3 Define the length of intertray jumper tube and mark. Proceed in the same way as per point 7.

16.4 Route the fibers in the jumper tube.

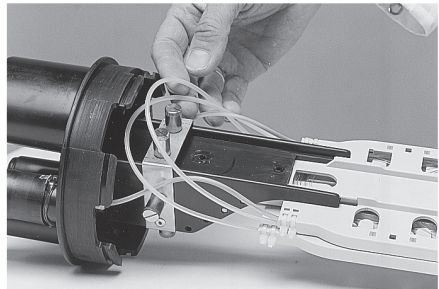

16.5 Carefully bend the intertray jumper tube to the appropriate tray and secure to the splice tray with two tie-wraps.

16.6 The fibers may now be spliced or stored.

To find out more about CommScope® products, visit us on the web at www.commscope.com

For technical assistance, customer service, or to report any missing/damaged parts, visit us at: <http://www.commscope.com/SupportCenter>

© 2017 CommScope, Inc. All rights reserved.

FOOSC, SMOUV and all trademarks identified by ® or ™ are registered trademarks or trademarks, respectively, of CommScope, Inc.

This document is for planning purposes only and is not intended to modify or supplement any specifications or warranties relating to CommScope products or services.

This product is covered by one or more U.S. patents or their foreign equivalents. For patents, see: www.commscope.com/ProductPatent/ProductPatent.aspx.